



# Ritual, Awards and Protocol *Manual*

**Legion** 

## IN FLANDERS FIELDS

In Flanders fields the poppies blow  
Between the crosses, row on row,  
That mark our place; and in the sky  
The larks, still bravely singing fly  
Scarce heard amid the guns below.

We are the Dead. Short days ago  
We lived, felt dawn, saw sunset glow,  
Loved, and were loved, and now we lie  
In Flanders fields.

Take up our quarrel with the foe:  
To you from failing hands we throw  
The torch; be yours to hold it high.  
If ye break faith with us who die  
We shall not sleep, though poppies grow  
In Flanders fields.

*Lt.-Col. John McCrae*



## **O CANADA**

O Canada! Our home and native land!  
True patriot love in all of us command.  
With glowing hearts we see thee rise,  
The True North strong and free!  
From far and wide, O Canada,  
We stand on guard for thee.  
God keep our land glorious and free!  
O Canada, we stand on guard for thee.  
O Canada, we stand on guard for thee.

## **Ô CANADA**

Ô Canada! Terre de nos aïeux,  
Ton front est ceint de fleurons glorieux!  
Car ton bras sait porter l'épée,  
Il sait porter la croix!  
Ton histoire est une épopée  
Des plus brillants exploits.  
Et ta valeur, de foi trempée,  
Protégera nos foyers et nos droits,  
Protégera nos foyers et nos droits.

# Table of Contents

<b>CHAPTER 1</b>	<b>1</b>
<b>LEGION DRESS</b>	
GENERAL	1
LADIES AUXILIARY	5
THE POPPY	5
THE RED MAPLE LEAF	6
LEGION MEMBER APPOINTED TO SPECIAL DUTIES	6
SERVICE ORDERS, DECORATIONS AND MEDALS	6
<b>Figure 1-1 - Wearing of Service Medals</b>	6
ORDER OF PRECEDENCE	7
LEGION MEDALS	8
MEDAL PRECEDENCE — THE ROYAL CANADIAN LEGION	9
ORDER OF CANADA AND SIMILAR ORDERS	11
MINISTER OF VETERANS AFFAIRS COMMENDATION	11
LADIES AUXILIARY	12
<b>CHAPTER 2</b>	<b>13</b>
<b>AWARDS</b>	
GENERAL	13
<b>AWARDS: LEGION MEMBERS</b>	<b>14</b>
MERITORIOUS SERVICE MEDAL (MSM)	14
MERITORIOUS SERVICE AWARD (MSA)	17
PALM LEAF TO THE MSM AND MSA	18
LIFE MEMBERSHIP	20
PER CAPITA TAX TO BE PAID FOR LIFE MEMBERSHIP	21
HONORARY LIFE MEMBERSHIP	22
CERTIFICATE OF MERIT	22
CERTIFICATE OF APPRECIATION	23
LEGIONNAIRE OF THE YEAR AWARD	24
50 YEAR LONG SERVICE MEDAL	24
<b>AWARDS TO OTHER THAN LEGION MEMBERS</b>	<b>24</b>
FRIENDSHIP AWARD	24
CERTIFICATE OF MERIT	25
CERTIFICATE OF APPRECIATION	25
MEDIA AWARD	25
FOUNDERS AWARD	26
<b>AWARDS: PAST LEGION SERVICE</b>	<b>27</b>
PAST OFFICE MEDALS	27
BAR TO PAST OFFICE MEDALS	27
PAST PRESIDENT/COMMANDER MEDAL	28
BRANCH/L.A. SERVICE MEDAL	28
LAPEL BADGES	29
APPLICATIONS - PAST OFFICE AWARDS	29
LISTING - PAST OFFICE AWARDS	29

<b>AWARDS IN RECOGNITION OF MERITORIOUS OR OUTSTANDING SERVICE</b>	<b>30</b>
<b>MEDALS, BARS, LAPEL BADGES AND CERTIFICATES</b>	<b>34</b>
GENERAL	34
MERITORIOUS SERVICE MEDAL AND AWARD	35
PAST SERVICE - DOMINION COMMAND	36
PAST SERVICE - PROVINCIAL COMMANDS	37
LADIES' AUXILIARY - PAST SERVICE PROVINCIAL COMMANDS	38
PAST SERVICE - DISTRICTS OR ZONES	39
LADIES AUXILIARY - PAST SERVICE - DISTRICTS OR ZONES	40
PAST SERVICE - BRANCHES AND POSTS	40
LADIES' AUXILIARY - PAST SERVICE - BRANCHES AND POSTS	42
PAST ANNIVERSARY MEDALS	42
CERTIFICATES	43
MISCELLANEOUS AWARDS	43
AWARDS FOR OTHER THAN LEGION MEMBERS	44
<b>AWARDS</b>	<b>45</b>
<b>CANADIAN HONOURS AND AWARDS</b>	<b>45</b>
GENERAL	45
PURPOSE	45
HONOURS	45
<b>ORDERS</b>	<b>46</b>
THE ORDER OF CANADA	46
GOVERNOR GENERAL'S AWARDS	46
SOVEREIGN'S MEDAL FOR VOLUNTEERS	46
NOMINATION PROCESS	46
NOMINATION FORMS	47
ENDORSEMENT	47
<b>CHAPTER 3</b>	<b>48</b>
<b>PROTOCOL</b>	
<b>LEGION MEETINGS</b>	<b>48</b>
<b>THE SOVEREIGN'S PICTURE</b>	<b>48</b>
INDIGENOUS LAND ACKNOWLEDGMENT	49
OPENING CEREMONY	49
FIGURE 3-1 — PARADING OF COLOURS AT LEGION MEETINGS	50
ORDER OF BUSINESS	51
CLOSING CEREMONY	51
LEGION ORDER OF PRECEDENCE	52
PARADES	54
BANQUETS	54
PROTOCOL AT FUNCTIONS	54
<b>CHAPTER 4</b>	<b>62</b>
<b>WELCOMING CEREMONY</b>	
GENERAL	62
WELCOMING	62
THE WELCOMING CEREMONY	62

<b>CHAPTER 5</b>	<b>65</b>
<b>INSTALLATION OF OFFICERS AND EXECUTIVE COMMITTEE MEMBERS</b>	
DRESS	65
ORDER OF CEREMONY	65
INSTALLING OFFICER	66
INSTALLATION OF THE SERGEANT-AT-ARMS	66
INSTALLATION OF THE SECRETARY	67
INSTALLATION OF THE TREASURER	68
INSTALLATION OF THE SECRETARY-TREASURER	69
INSTALLATION OF THE CHAIR	70
INSTALLATION OF THE BRANCH SERVICE OFFICER	71
INSTALLATION OF THE CHAPLAIN	72
INSTALLATION OF THE EXECUTIVE COMMITTEE	72
INSTALLATION OF THE VICE-PRESIDENTS	73
INSTALLATION OF THE PAST PRESIDENT	74
INSTALLATION OF THE PAST DISTRICT/ZONE COMMANDER	75
RECOGNITION OF THE HONORARY OFFICERS (OPTIONAL)	75
INSTALLATION OF THE PRESIDENT	76
INSTALLATION OF THE PRESIDENT	77
INSTALLATION OF THE DEPUTY/VICE ZONE COMMANDER	78
INSTALLATION OF THE ZONE COMMANDER	79
INSTALLATION OF THE ZONE COMMANDER	80
INSTALLATION OF THE DEPUTY/VICE DISTRICT COMMANDER	81
INSTALLATION OF THE DISTRICT COMMANDER	82
INSTALLATION OF THE DISTRICT COMMANDER	83
INSTALLATION OF A BRANCH REPRESENTATIVE	83
INSTALLATION OF A PROVINCIAL REPRESENTATIVE	
TO THE DOMINION EXECUTIVE COUNCIL	84
INSTALLATION OF A PROVINCIAL CHAIR	
AND VICE-CHAIR	85
<b>CHAPTER 6</b>	<b>86</b>
<b>CEREMONIES AND EVENTS</b>	
REMEMBRANCE DAY CEREMONIES	86
COLOURS - DIPPING	88
DEDICATION OF A MEMORIAL	88
ORDER OF SERVICE	89
CEREMONY - OPENING A LEGION HALL	90
HONOURS AND AWARDS PRESENTATIONS	91
GENERAL PURPOSE GRACE AND INVOCATION	92
<b>CHAPTER 7</b>	<b>93</b>
<b>LEGION FUNERALS</b>	
INTRODUCTION	93
VETERAN - DEFINED	93
TYPES OF LEGION FUNERAL SERVICES	94
SYMBOLS	94
NOTIFICATION OF A DEATH	94
ACTIVITIES - THE LEGION TRIBUTE	95
CEREMONIAL ACTIVITIES	98

FIGURE 7-1 — PLACEMENT OF FLAG, BERET, MEDALS AND WREATH	99
<b>FUNERALS FOR VETERANS AND ORDINARY MEMBERS</b>	<b>101</b>
THE FUNERAL SERVICE	101
A LEGION GRAVE SIDE SERVICE	102
A LEGION MEMORIAL SERVICE	103
FUNERALS FOR ASSOCIATE AND AFFILIATE LEGION MEMBERS AND MEMBERS OF THE LADIES AUXILIARY	<b>104</b>
PREFACE	104
THE FUNERAL SERVICE	104
A GRAVESIDE SERVICE	105
A MEMORIAL SERVICE	106

## **CHAPTER 8** . . . . . **107**

### **CENOTAPHS**

## **CHAPTER 9** . . . . . **109**

### **FLAGS, COLOUR PARTIES AND PARADES**

FLAGS AND BANNERS	109
FIGURE 9-1 — FLAG FORMATIONS	111
GENERAL FLAG ETIQUETTE	111
FIGURE 9-2 — FLAG TERMINOLOGY	112
FLAG SIZE	113
FLAGPOLE LENGTH	113
HALF-MASTING	114
MEMORIAL AND FUNERAL SERVICES	117
THE COLOUR PARTY	117
PARADES	119
LARGE ASSEMBLIES	120
FIGURE 9-3 — PLACING/RECOVERING COLOURS (LARGE ASSEMBLY)	122
CONVENTIONS	122
FIGURE 9-4 — PLACING/RECOVERING COLOURS (CONVENTION)	123
OTHER OCCASIONS	124
ORDER OF PRECEDENCE	124
THE BRANCH COLOUR PARTY	124
MASSED BRANCH COLOUR PARTY	124
FIGURE 9-5A — “ON THE MARCH”	124
FIGURE 9-5B — “IN LINE”	124
FIGURE 9-6 — “FORM LANE”	124
FIGURE 9-7 — MASSED BRANCH COLOUR PARTY	125
JOINT BRANCH/POST PARADES	125
FIGURE 9-8 — JOINT BRANCH/POST PARADES IN CANADA (POST)	125
FIGURE 9-9 — JOINT BRANCH/POST PARADES IN USA (BOTH)	125
CONSECRATION OF COLOURS (DRUMHEAD SERVICE)	125
FIGURE 9-10 — POSITION FOR THE MARCH-ON	126
FIGURE 9-11 — POSITIONS AT CEREMONY	126
FIGURE 9-12 — MARCH PAST	129

<b>CHAPTER 10</b>	<b>130</b>
<b>BASIC DRILL MOVEMENTS</b>	
<b>WORDS OF COMMAND</b>	<b>130</b>
BASIC DRILL MOVEMENTS	131
FIGURE 10-1 — ATTENTION	131
FIGURE 10-2 — STAND AT EASE	132
FIGURE 10-3 — REMOVE HEADDRESS	133
COMPLIMENTS AND WREATH-LAYING PROCEDURES	134
FIGURE 10-4 — SALUTING AT THE HALT	138
FIGURE 10-5 — SALUTING ON THE MARCH	138
FIGURE 10-6 — EYES RIGHT	139
FIGURE 10-7 — RIGHT TURN AT THE HALT	140
FIGURE 10-8 — ABOUT TURN AT THE HALT	140
FIGURE 10-9 — DRESSING	141
FIGURE 10-10 — MARCHING IN QUICK TIME	143
FIGURE 10-11 — HALTING IN QUICK TIME	143
FIGURE 10-12 — MARKING TIME FROM QUICK TIME	144
FIGURE 10-13 — ABOUT TURN ON THE MARCH IN QUICK TIME	145
FIGURE 10-14 — LEFT TURN ON THE MARCH IN QUICK TIME	146
FIGURE 10-15 — HOLDING THE PACE STICK AT ATTENTION/AT EASE	147
FIGURE 10-16 — SALUTING WITH A PACE STICK	147
<b>COLOUR PARTY DRILL</b>	<b>148</b>
GENERAL	148
FIGURE 10-17 — COLOUR BEARER	148
COLOUR PARTY DRILL MOVEMENTS	148
FIGURE 10-18 — THE ORDER	149
FIGURE 10-19 — AT EASE	149
FIGURE 10-20 — CARRY FROM THE ORDER	150
FIGURE 10-21 — ORDER FROM THE CARRY	151
FIGURE 10-22 — SLOPE FROM THE CARRY	152
FIGURE 10-23 — CARRY FROM THE SLOPE	153
FIGURE 10-24 — LET FLY FROM THE CARRY	154
FIGURE 10-25 — CATCHING THE COLOUR FROM THE LET FLY	155
FIGURE 10-26 — THE DIP	156
FIGURE 10-27 — DRAPING THE COLOUR	157
<b>REMEMBRANCE MUSIC</b>	
THE LAST POST	158
ROUSE	159
UNITY	160
ROYAL ANTHEM	166
HYMNE ROYAL	166
<b>LEGION MEDALS AND PRECEDENCE</b>	<b>167</b>

## NOTES

THE MATERIAL PROVIDED IN THIS PUBLICATION IS THE SOLE PROPERTY OF THE ROYAL CANADIAN LEGION AND SHALL NOT BE REPRODUCED IN ANY FORM WITHOUT THE EXPRESSED WRITTEN PERMISSION OF DOMINION COMMAND, THE ROYAL CANADIAN LEGION. THIS MANUAL AMPLIFIES LEGION POLICY AND IS PRODUCED UNDER THE AUTHORITY OF THE DOMINION EXECUTIVE COUNCIL AS PER ARTICLE 408 OF THE GENERAL BY-LAWS.



**FIGURE TC-1 - LEGEND FOR FLAG DIAGRAMS**

The legend is to be used when referring to the figures shown in the manual.

<b>1</b>	<b>CANADIAN</b>	<b>11</b>	<b>PRINCE EDWARD ISLAND</b>
<b>2</b>	<b>RED ENSIGN</b>	<b>12</b>	<b>SASKATCHEWAN</b>
<b>3</b>	<b>ROYAL UNION FLAG A.K.A. UNION JACK</b>	<b>13</b>	<b>ALBERTA</b>
<b>4</b>	<b>AMERICAN</b>	<b>14</b>	<b>NEWFOUNDLAND &amp; LABRADOR</b>
<b>5</b>	<b>ONTARIO</b>	<b>15</b>	<b>NORTHWEST TERRITORIES</b>
<b>6</b>	<b>QUEBEC</b>	<b>16</b>	<b>YUKON</b>
<b>7</b>	<b>NOVA SCOTIA</b>	<b>17</b>	<b>NUNAVUT</b>
<b>8</b>	<b>NEW BRUNSWICK</b>	<b>18</b>	<b>UNITED NATIONS</b>
<b>9</b>	<b>MANITOBA</b>	<b>19</b>	<b>NATO</b>
<b>10</b>	<b>BRITISH COLUMBIA</b>	<b>20</b>	<b>LEGION BANNER</b>
<b>P</b> <b>PROVINCIAL/TERRITORIAL</b>			
<b>⊙</b>	<b>PARADE COMMANDER</b>	<b>⊕</b>	<b>SGT-AT-ARMS/ COLOUR PARTY COMMANDER</b>

# Introduction

The Ritual & Awards and Protocol Committee has considered all recommendations, resolutions and enquiries which have been forwarded to Dominion Command and they have been incorporated wherever feasible in this edition of The Ritual, Awards and Protocol Manual. In addition, all resolutions adopted up to and including the 2018 Dominion Convention, have also been included.

The former Ritual and Insignia Manual, Honours and Awards Manual, National Honours Manual and Protocol Manual have all been integrated and revised into this one manual. Legion members at all levels are encouraged to use this integrated manual for information purposes. This information is available on the Legion website - **www.legion.ca**. Any deviations from this manual should be rare and only due to local circumstances that are unique.

When a guest speaker or Legion official is expected to perform ceremonial duties, it is recommended that, prior to the ceremony, a rostrum or lectern provided with adequate sound and lighting be available. A copy of this manual should also be available for reference purposes.

We trust that Legionnaires will make good use of The Ritual, Awards and Protocol Manual and, in so doing, achieve a standardized method of operation throughout The Royal Canadian Legion.

This manual is issued by the Dominion Command Ritual, Awards and Protocol Committee, under the authority of the Dominion Executive Council.

---

**NOTE: In the back of the manual there are several pieces of music, one of which is titled Rouse. This is, in fact, the actual title of this piece of music, even though it has been erroneously referred to in Legion publications as Reveille. This misnomer has been a source of confusion in conversation with Canadian Armed Forces personnel for many years. In the interest of accuracy and standardization, the Ritual, Awards and Protocol Manual will henceforth use the correct title Rouse for this piece of music.**

---

# Legion Dress

## GENERAL

- 101.** Legion Dress will be worn while attending any formal Legion function that would include;
- a.** Commemorative ceremonies such as Remembrance Day parades, all ceremonies held at Cenotaphs, Decoration Day and Memorial Day, Church Parades;
  - b.** All Tributes and/or funerals of Legion members.
  - c.** At installation ceremony by those comrades participating in the installation. (I.e. The installing officer, the comrade(s) being installed, the Sergeant-at-arms and members of the Colour Party.
  - d.** Visits by Command Officers to Branches.
  - e.** Legion banquets, especially Remembrance banquets.
  - f.** When representing the Legion at meetings or events other than those of the Legion.
  - g.** Other occasions where, in the opinion of the body issuing the invitation or instruction.
  - h.** All Officers or Executive members occupying a position at the Head Table of any Legion function.
  - i.** Members of the Colour Party, including the Party Commander and Parade Commander.
  - j.** Where appropriate.

Legion Informal Dress will consist of a blue shirt, available only through Legion supply, will be embroidered with the Legion crest. A Legion name tag may be worn on the right side of the blue shirt, below the collar, centered with the bottom of the nametag levelled/lined up with the upper edge of the pocket. Undress Service ribbons can be worn on the left side, levelled/lined up with the right side nametag. No other pins, member designation pin, blazers, ties, epaulettes, shoulder badges, medals, or else are to be worn with Legion Informal Dress.

- a. Business Occasions**
  - Convention business sessions, excluding the opening ceremonies.
  - Various Legion meetings, i. e. Executive, General and Special (Note: Shirt must also be worn with black shoes, grey trousers for males and black shoes, grey hose, grey knee length skirts or slacks for females.)
- b. Informal Occasions**
  - Informal Branch events.
  - Hospital visitations to Veterans.

- Where appropriate  
(Note: Grey trousers/skirts and black shoes not required.)

**102. Standard Legion Dress.** The order of dress for Legion activities is as follows:

- a. Navy blue beret with Legion beret crest;
  - i. Brass Branch numerals may be worn on the beret, parallel to the head band and the first number is to be 3/8" to the wearer's left of the beret badge;
  - ii. The beret is worn with the band one inch above the eyebrows, the beret crest over the left eye, the beret pulled back and smoothed to the right side;

**Or**

- b. Headdress acquired during current or previous service with Canadian or Allied Forces including Regular members of the Royal Canadian Mounted Police (excluding ceremonial and peaked caps) complete with the service cap badge of the unit/regiment/service being served or was served.

This type of headdress may not be worn by Colour Party members including the Colour Party Commander and Parade Commander;

- c. **Legion Dress – Headdress.** It is not normal practice for headdress to be worn indoors with the exception of the Sergeant-at-Arms, Colour Bearer(s), members of the Ladies Auxiliary, by members whose religious doctrine or customs require that the head be covered and by Officers presiding at official functions, such as Installations and may also include those who are being installed.

Some Branches, Zones, Districts and Commands have developed a tradition to wear headdress during opening and closing ceremonies. Although unusual, such traditions are not discouraged by the Royal Canadian Legion. Where employed, these practices will be at the call of the Senior Officiating Officer;

- d. Legion headdress is to be worn at all outside ceremonial events when Legion dress is being worn;
- e. When headdress is worn inside a building on appropriate ceremonial occasions, the protocol for wear is the same for men and women;

- f. Navy blue blazer, complete with the appropriate Legion blazer crest on the left-hand breast pocket and Legion buttons on the front and on the sleeves. A Regimental Service Blazer Badge of the unit/ regiment/service being served or was served or a Royal Canadian Mounted Police Blazer Badge may be worn on the lower right side pocket of the Legion Blazer. If for any reason the wearing of the Regimental Badge or Royal Canadian Mounted Police Badge on the lower right side pocket would appear to bring discredit to the unit/regiment/service, then and only then, would the Badge be allowed to be worn on the lower left side pocket.
- g. A Veteran sew on scroll may be worn on the Legion blazer by all Legion members who qualify as a Veteran as described in Section 101 2. of our GBLs. The scroll is authorized for wear on the Legion blazer on the left-hand breast pocket directly below the Legion blazer crest. This includes L.A. dress.
- h. Black shoes, black socks, grey trousers for males and black shoes, dark grey hose, grey knee length skirts or slacks for females. Black shoulder strap purses may be carried on parade and small stud or keeper earrings are appropriate for females;
- i. Plain white shirt and the official Legion long striped tie;
- j. White gloves are worn by comrades participating at ceremonies.




---

**Note: This manual describes Legion dress only and not civilian dress. Civilian dress including headdress is addressed through Branch House Rules.**

---

- 103. Summer Dress.** This order of dress may be worn in Canada from the 1st day of May to the last day of September each year in accordance with climatic conditions. Dress for events may be determined in accordance with climatic conditions at all times throughout the year. Summer dress should be worn on occasions where, in the opinion of the body issuing the invitation or instruction, the wearing of summer dress would be appropriate. This would include Colour

Parties. Summer dress is the same as for the standard Legion dress except that blazers are not worn, ties are optional, a Legion shirt badge is displayed on the shirt pocket, and no epaulettes, shoulder badges, or medals are to be worn. Undress Service Ribbons may be worn.

**104. Formal Dress.** From time to time, Legion Officers are called upon to attend formal military or civilian events. Some invitations call for Black Tie and others call for White Tie. Tuxedo/Dinner Jacket attire does not properly identify the Officers as Legion representatives. While Standard Legion dress qualifies as Association Dress, the wearing of blues and greys with standard medals and with long Legion tie, pocket badges and name tags, etc., does not fit the normal requirement of ‘formality’ for these occasions. Dominion Executive Council has authorized the following as optional Legion Dress for all ‘formal’ occasions, military or civilian, where black tie or white tie formal dress is called for:

- a. Legion blazer including Legion left breast pocket crest;
- b. One Legion lapel badge + Canadian Armed Forces Service pin (as applicable), worn on left lapel;
- c. Canadian Honours, i.e., Order of Canada neckwear, lapel badge (as appropriate);
- d. Minister of Veterans Affairs Decoration (as appropriate);
- e. Miniature Service Medals;
- f. White formal shirt w/standard fold-down collar;
- g. Black/white formal bow tie;
- h. Black cummerbund;
- i. Dark suspenders may be worn;
- j. Grey trousers;
- k. Black socks;
- l. Black shoes;
- m. Ladies – as above but including optional dark hose and formal length grey skirt;
- n. Legion or military association headdress is appropriate but optional with formal Legion dress;
- o. Association right pocket badge not recommended with formal dress;
- p. Name badges and commemorative or support the troops pins are not to be worn on the right lapel of formal Legion dress.

**105. ACCOUTREMENTS.** Items that are included with Legion dress are as listed below:

- a. Lapel and blazer badges with appropriate scrolls are to be worn by members;
- b. A Legion name tag may be worn on the right side of the Legion blazer above Legion medals;
- c. Only one Legion lapel badge shall be worn on the left lapel of the blazer. A Canadian Armed Forces Service lapel pin may also be worn to the left of the Legion lapel badge
- d. The wearing of one embroidered or metal Canadian Specialist Skill Badge of choice that has been earned by the member while serving in the CAF, RCMP or as a First Responder, or who has honourably served in the Commonwealth or Allied Forces, is authorized for wear on the left side of Legion Dress centered immediately above Service Medals/Undress Ribbons;
- e. From time to time commemorative or celebratory pins may be authorized for wear only for a specified time. These items shall be the only pins worn on the right lapel of the Legion blazer and shall be parallel to the Legion badge;
- f. A parade commander, colour party commander or sergeant-at-arms may wear a red sash. The sash is worn over the right shoulder across the body to the left hip. Other than the Legion Badge, no other items are to be worn on the sash;
- g. Overcoats may be worn in inclement weather;
- h. A parade commander may authorize a parade to remove their blazers when considered necessary and appropriate. See Section 103 – Summer Dress.

### **LADIES AUXILIARY**

**106.** Dress for members of the Ladies' Auxiliary is under the jurisdiction of Provincial Commands.

### **THE POPPY**

**107.** The Poppy is worn by Legion members during the annual Remembrance period which commences the last Friday in October and ends immediately following Remembrance Day. Other occasions when the Poppy may be worn are during special Remembrance services such as a service at a Legion Convention, The Battle of the Atlantic, The Battle of Britain, etc. The Poppy is also authorized for wear by Legion Colour Parties when on parade and by members attending funeral services for veterans or ordinary members.

- 108. The Lapel Poppy is worn on the left lapel immediately above the Legion lapel badge when wearing Standard Legion Dress.
- 109. The Lapel Poppy is worn on the shirt, immediately above and centred on the shirt badge when wearing Summer Dress.
- 110. When faced with inclement weather the Lapel Poppy is worn on the left side of the outer garment close to the heart.

### THE RED MAPLE LEAF

- 111. The Red Maple Leaf may be worn during the Legion Tribute at the funerals of Ladies Auxiliary members and Legion members who were not veterans or ordinary members. The Red Maple Leaf is worn in the same manner as the Lapel Poppy. This is the only occasion where the Red Maple Leaf is authorized to be worn or utilized.

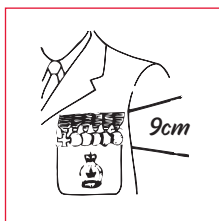
### LEGION MEMBER APPOINTED TO SPECIAL DUTIES

- 112. There may be an occasion and the honour for a Legion member to be assigned to fulfil special duties and responsibilities. As such, this may be an exceptional honour and privilege which not only recognizes the person assigned to these duties but also recognizes the Legion as an organization. When a member is approached to take on these duties contact is to be made with Dominion Command to obtain the manner in which Legion dress is worn.

### SERVICE ORDERS, DECORATIONS AND MEDALS

Figure 1-1 - Wearing of Service Medals

- 113. Service medals should be worn above the left breast pocket



and on full Legion dress on such Legion occasions as:

- a. Commemorative ceremonies such as Remembrance Day parades, all ceremonies held at cenotaphs, Decoration Day and Memorial Day;



- b. Church parades;
- c. At tributes and/or funerals of Legion members;
- d. At an initiation ceremony by those comrades participating in the initiation, for example - the Presiding Officer, the Chair of the Membership Committee and the comrade reciting the Purposes and Objects of The Royal Canadian Legion;
- e. At an installation ceremony by those comrades participating in the installation, for example - the Installing officer, the comrade(s) being installed, the Sergeant-at-arms and members of the Colour Party;
- f. Opening and closing of a convention;
- g. Visits by command officers to Branches;
- h. Legion banquets, especially Remembrance banquets;
- i. Other occasions where, in the opinion of the body issuing the invitation or instruction, the wearing of service medals would be appropriate. A General Meeting of the Branch may be considered such an occasion.
- j. The wearing of legion or service medals of a deceased member is prohibited.

114 . If medals are not available, Undress Service Ribbons may be worn on Legion Dress.

---

**NOTE: It is an offence under Sections 419 A and B of the Criminal Code of Canada for anyone, other than the recipient, to wear a uniform of the Canadian Armed Forces or Service Insignia, such as medals, ribbons, badges, chevrons or other decoration. It is also an offence for anyone to wear any imitation of the above if it is likely to be mistaken for the said uniform, or service insignia, etc.**

---

## ORDER OF PRECEDENCE

115. The order of precedence in which service medals shall be worn is under the jurisdiction of The Chancellery at Government House. From time to time, the order of precedence is amended. In the event there are questions as to the wearing of a medal, members are advised to communicate with The Chancellery regarding such matters at 1-800-465-6890 or write:

**The Chancellery  
Office of the Secretary to the Governor General  
Government House,  
1 Sussex Drive, Ottawa Ontario, K1A 0A1.**

The information may also be found on the Internet at **www.gg.ca** and follow the links to the Chancellery.

- 116. Miniature Medals.** These medals may be worn on the Legion blazer on social occasions such as Legion banquets, but are not to be worn on parade.

## **LEGION MEDALS**

- 117.** Legion medals are worn on full Legion dress on the right breast in order of precedence from wearer's centre to right, in a single row and in a horizontal position that corresponds to the position of service medals which are worn on the left breast (also see Section 121).
- 118.** The ribbons for Legion medals are 1½" wide and have a visible length of 2".
- 119.** Legion medals should be worn on such Legion occasions as described in Section 113 of this manual.
- 120.** Medals awarded by the Legion may only be worn by the members to whom they are awarded and may only be worn on Legion uniforms or formal Legion dress described in Section 104 in the order of their seniority of office and in the following order:
- a.** The Meritorious Service Medal (MSM);
  - b.** Dominion level Past Office medals;
  - c.** Provincial level Past Office medals;
  - d.** District level Past Office medals;
  - e.** Zone level Past Office medals;
  - f.** Branch level Past Office medals;
  - g.** The Long Service Medal which denotes 50 years of continuous service;
  - h.** Branch Service Medal;
  - i.** Other Legion medals, such as Anniversary Commemorative medals and the Cadet/Junior Ranger medal, in the order that they have been received.
- 121.** All Legion medals, including commemorative medals, distributed and sold by Dominion Command to Branches, Districts, Zones, Ladies Auxiliary's and Provincial Commands, be clearly identified as "not for resale to the public or individual not members of the Legion" and that no Legion medals be sold to the public or individuals outside of replacement of these medals.

## MEDAL PRECEDENCE — THE ROYAL CANADIAN LEGION

CANADA AND EUROPE	UNITED STATES	LADIES AUXILIARY
Meritorious Service Medal	Meritorious Service Medal	Meritorious Service Award
Dominion Past President	Zone Past Commander	Provincial Past President
President (TVS)	Zone Past Office	Provincial Past Office
Dominion Past Office	Branch/Post Past	District Past Office
Dominion Past	President/	Zone Past Office
Committee Member	Commander	Branch/Post Past
Provincial Past President	Branch/Post Past Office	President/
Provincial Past President (IMP)	Branch Service Medal	Commander
Provincial Past President (TVS)	Anniversary and	Branch Past Office
Provincial Past Office	Commemorative	L.A. Service Medal
District Past Commander	Medals and Canadian	Anniversary and
District Past Office	Junior Rangers	Commemorative
Zone Past Commander	(Canada only)	Medals
Zone Past Office	(In the order received)	(In the order received)
Branch Past President	See Section 128	See Section 128
Branch Past Office		
Branch Service Medal		
Anniversary and		
Commemorative		
Medals and Cadet/Junior		
Ranger medal		
(Canada only)		
(In the order received)		

**122. Photograph—Legion Medals.** A photograph depicting seven Legion medals is shown on page 166 of this manual. The photograph identifies the medals and shows the manner and precedence in which they are worn which is as follows:

- a. The MSM with Palm Leaf;
- b. A Past Provincial Office medal with a Vice-President bar;
- c. A District Past Office medal with a District Bar;
- d. A Zone Past Office medal with a Zone Bar;
- e. A Branch Past President medal;
- f. A Branch Past Office medal with a 1st Vice-President Bar;
- g. An Anniversary Medal, in this case the 90th Anniversary Medal.

123. Only one Past President, one Past Commander and one Past Office medal from each command level or branch shall be worn, regardless of whether a member has served at more than one command or branch.
124. These medals should be properly mounted in accordance to CF directives at: [www.canada.ca/en/services/defence/caf/military-identity-system/dress-manual/chapter-4.html#4-7](http://www.canada.ca/en/services/defence/caf/military-identity-system/dress-manual/chapter-4.html#4-7)
125. Offices held at the various command levels of the Legion are designated by bars which may be attached to the ribbon of Past Office medals. Only one bar shall be worn for a specific office at each level, even though the member may have held the office for more than one term, or at more than one command or branch. A maximum of four bars can be attached to one medal. The choice of which four to attached is the sole decision of the member.
126. **Branch Service Medal and L.A. Service Medal.**  
These medals are a tangible, visible method of recognizing the significant efforts of hard-working, behind-the-scenes members. See Section 270.
127. **Awards from Veterans' and Other Organizations.**  
Awards received by Legion members from veterans' and other organizations as authorized by Dominion Command are worn on the right breast after all Legion awards. These awards are worn in the order they are received. (Also see Section 243).

---

**NOTE: Dominion Executive Council has confirmed that medals issued for "positions served, years of service, etc." in Veterans' and other organizations, other than the Legion, and the Canadian Cadet Medal of Excellence, are not permitted to be worn on Legion Dress.**

---

128. **Commemorative Medals.** From time to time governments and organizations produce commemorative medals. Approved for wear on Legion dress are the Dutch Medal (Medal of Remembrance in relation to the liberation of Holland) and the Normandy Medal (Medal of the Jubilee of Liberty), which were issued in commemoration of the 60<sup>th</sup> Anniversary of the Liberation of the Netherlands and The Allied landing at Normandy. Also included in this category is the Cadet/Junior Ranger medal. They are to be worn on the right breast, after all Legion Medals, in the order in which they were received. See Section 120 for order of precedence. Medals of this nature that

have not been approved by the Government of Canada or Dominion Command shall not be worn on Legion dress.

- 129. The Cadet/Junior Ranger medal.** This medal is governed by each cadet corps/squadron and can be worn on Legion dress. The awarding of this medal is based upon a recognized national standard established by the Canadian Armed Forces. The corps/squadron CO is the approving authority for the awarding of this medal. It is awarded to one cadet per corps/squadron annually in recognition of individual endeavors in citizenship which enhance the aims and objectives of the Canadian Cadet movement.

For reference and selection criteria see Section 13-16 Annex E of the Cadet Administrative and Training Orders (CATOs) at <https://www.canada.ca/en/department-national-defence/services/cadets-junior-canadian-rangers/cjer-policy/catos/volume1/13-series/13-16/13-16-e.html>.

#### **ORDER OF CANADA AND SIMILAR ORDERS**

- 130.** From time to time, Legion members may receive high decorations such as the Order of Canada and similar Orders. While instructions for wear are included with such Orders, the Dominion Executive Council has approved the following in order to acknowledge the achievements of these members:
- a. Neck badge(s) and Stars may be worn with Legion dress, on occasions when the wearing of medals is appropriate. They are not to be worn on Legion dress when the wearing of medals is not appropriate;
  - b. Lapel badge(s), for such decorations, may be worn, on the left lapel, on all occasions, whether the full size or miniature insignia or undress service ribbons are being worn or otherwise;
  - c. On the occasion of promotions within an Order, only the most senior level lapel badge may be worn on Legion dress;
  - d. Lapel Badge(s), for such decorations, may be worn, on the left lapel, in addition to the lapel badges currently approved for wear on Legion dress;
  - e. To demonstrate the high honour recognized by the Order of Canada and similar Orders, the Lapel badge is authorized to be worn immediately above the Legion lapel badge.

#### **MINISTER OF VETERANS AFFAIRS COMMENDATION**

- 131.** From time to time, Legion members may receive the Minister of Veterans Affairs Commendation in recognition of their

significant efforts on behalf of Veterans. The award consists of a certificate, a lapel badge (for civilian wear) and a bar for wear with decorations. The Commendation is worn below official decorations on its gold bar. It can be worn on veterans' blazers, formal wear, etc. on occasions when it is appropriate for medals to be worn. The Dominion Executive Council has approved the following in order to acknowledge the achievements of these members:

- a. The Commendation Bar may be worn on the left side of Legion Dress, below other Service Medals and/or decorations, and centered directly below the Legion Blazer Badge or below the Veterans Scroll that forms a part of the Legion Blazer Badge. It is not to be worn on Legion dress on occasions when the wearing of Service Medals and/or official decorations is not appropriate;
- b. The Commendation lapel badge may be worn, on the left lapel of Legion dress on all occasions, whether the Bar and other Service Medals and/or official decorations are being worn or otherwise;
- c. The Commendation lapel badge shall be worn to the left of the Legion Lapel badge on Legion dress or to the left of the service discharge button or a Canadian Armed Forces Service lapel pin, as appropriate;
- d. The Commendation lapel badge may be worn at any time on civilian dress.

### **LADIES AUXILIARY**

132. Medals awarded by the Ladies Auxiliary may be worn on Ladies Auxiliary uniforms or equivalent civilian apparel. Where the member is both a Ladies Auxiliary member and a Legion member, medals awarded by the Ladies Auxiliary may also be worn on Legion uniforms after all medals awarded by the Legion in accordance with Sections 117 and 124.
133. If a L.A. member becomes a Legion member for extenuating circumstances such as their L.A. is surrendering their charter OR they transfer to a Branch that does not have a L.A., medals awarded by the Ladies Auxiliary may also be worn on Legion uniforms.
134. Legion medals other than Anniversary Commemorative medals, shall not be worn on the Ladies Auxiliary uniform.

# Awards

## GENERAL

- 201. Awards.** Members may be selected and recommended for Legion awards at the Branch, Zone, District, Provincial and Dominion levels. Branches, Zones and Districts must submit applications to their Provincial Command for approval. Provincial Command Honours and Awards Committees are responsible for the following action:
- a. Screening applications received from Branches, Zones and Districts;
  - b. Ensuring that the citations, for awards that must be approved by the Dominion Command Ritual, Awards and Protocol Committee, provide detailed and clear information with dates that addresses the achievements of the member that merit the award; and clearly sets out what the member has done;
  - c. Ensuring all of the information that is required has been provided such as minutes and all areas of the form have been completed;
  - d. Ensuring that copies of applications for previous awards have been included (i.e. Life Membership and MSM/MSA);
  - e. Posthumous awards will only be granted when the original motion, as passed by the Branch, Zone, District or Command concerned, is dated prior to the death of the intended recipient;
  - f. The date that appears on the award is the date it was approved by the awarding authority;
  - g. Members who are employees of the Legion are eligible to receive Legion honours and awards, providing the award is for service rendered other than for duty as a paid employee.
  - h. The age and health of the member being nominated for such awards are not a consideration.
  - i. Ensuring that if an application has been returned for further information, that the added information is obtained and attached to the original application submission and re-submitted to Dominion Command.

- j. Flow to a perfect application and Sample Citation can be found in attachment to the manual along with the application form.

---

**NOTE: It is recommended that the presentation of the award occurs within three months of the award being received BY THE BRANCH, ZONE, DISTRICT OR COMMAND.**

---

## **AWARDS: LEGION MEMBERS**

### **MERITORIOUS SERVICE MEDAL (MSM)**

202. This is the highest award that can be granted to, Ordinary, Associate or Affiliate Voting Members. It is normal practice that when consideration is being given to recommending a person for an MSM, that the normal progression for major awards has been followed.
203. Approval of the MSM is the responsibility of the Dominion Command Ritual, Awards and Protocol Committee.
204. Criteria. Comrades who have the responsibility of recommending a fellow comrade for the MSM must ensure that the person being nominated is indeed worthy of consideration and that all of the accomplishments since the last award, including dates, are included in the application. The citation that accompanies the nomination must be based on the activities of the individual and these activities must exceed the standard that is expected of a member.
205. In order to determine if an individual should be nominated for the MSM those comrades responsible for the nomination must ask themselves the following questions:
  - a. How long has the member being considered been a member of the Legion?

---

**Note: For example, the criteria for receiving a Life Membership is that a member has provided outstanding Legion service for ten years of continuous membership.**

---



- b. Flowing from the above are specific factors that must be considered when determining if a nomination for the MSM is justified. The question that must be answered is - regardless of the offices held, what are the outstanding services that set the member apart from all of the others? **Examples of answers to this question could be:**
- i. three to five years as a Service Officer with a track record of demonstrated success in obtaining the appropriate assistance for those in need;
  - ii. activities on behalf of veterans and their dependants who are disabled or have special needs;
  - iii. obtaining, organizing and distributing hospital comforts and visiting shut ins over a period of years;
  - iv. taking on the responsibility for Legion drop in centres, meals on wheels, cultural and recreational or similar activities on behalf of the elderly, shut ins or disabled;
  - v. creating, organizing and implementing youth programs that provide positive experiences for young adults and demonstrate that the Legion is a vital part of the community;
  - vi. planning, organizing and managing the Poppy Campaign over a period of years;
  - vii. planning and organizing events or activities to build or upgrade Legion facilities such as branches and housing;
  - viii. identifying a need in the community or the Legion and taking the action required to fill the need;
  - ix. acting as the point of contact between the Legion and other community organizations to ensure that efforts are coordinated when the task is too great for one organization;
  - x. organizing branch resources to assist the community during a disaster or other pressing need;
  - xi. contributions of personal sacrifice, time or professional expertise that has brought great credit to the branch and to the community, or has enhanced the image of the Legion within the community;

- xii. as stated above, these are but a few examples of the type of effort that should be considered when recommending a comrade for an MSM.
206. In short, when contemplating these nominations the overriding consideration is - **does the service to the Legion so exceed that of any other member that it can only be properly recognized by bestowing the MSM?**
207. The nominations **must be approved** at an Executive or General Meeting of the Branch or Command and prepared using the Dominion Command Form 800281 (latest edition). The following information is to be included on the application form:
- a. The membership strength of the Branch must be shown, as service in a small or large community may have an impact;
  - b. The date and type of meeting where the award was approved, “ that a copy of the minutes of the meeting where the application was approved are attached to the application form. **The minutes must include the name(s) of the member(s) the award(s) being applied for, and the name of the nominator and seconder. The minutes must also be signed by the appropriate signing authorities.** If it is the wish to keep the name(s) of the applicant(s) confidential, an ‘in camera’ provision could be utilized at an Executive Meeting to discuss the application(s). The minutes of the ‘in camera’ portion of the meeting are to be included with the rest of the Executive Meeting minutes when submitting the application and **must** include the name(s) of the member(s) and the award(s) being applied for and the name of the nominator and seconder.
  - c. The application must be completed, signed and submitted in accordance with any specific Provincial Command rules respecting honours and awards;
  - d. The application must be signed by two senior Branch Officers, preferably the President and the Secretary;
  - e. When completed, the application, in the number of copies required by the applicable Provincial Command, is to be submitted to that Command;
  - f. An application from a Zone or District must be approved at a properly constituted meeting of the Zone or District, completed, signed and submitted as noted above.

208. The Citation. Care must be taken in preparing the citation. It must be remembered that the members of the Dominion Command Ritual, Awards and Protocol Committee have only the citation on which to base decisions. Therefore, complete details, including dates, must be provided of the outstanding services rendered in the Legion and any community service by the member being recommended. If awarded, a copy of the citation from Life Membership application would aid the Committee in making their decision.
209. The MSM medal, lapel badge, plaque, certificate and a distinctive card accompany the award.
210. The MSM can only be awarded once, regardless of the level.

### **MERITORIOUS SERVICE AWARD (MSA)**

211. This award is granted to eligible members of the Ladies Auxiliary who have rendered outstanding meritorious service to The Royal Canadian Legion. This is the highest award which can be made to a member of the Ladies Auxiliary. The criteria used to determine if an MSM is warranted is also used when considering MSA nominations on behalf of members of the Ladies Auxiliary.
212. Approval of the MSA is the responsibility of the Dominion Command Ritual, Awards and Protocol Committee.
213. The nomination must be approved at an Executive or General Meeting of the Ladies Auxiliary to the Branch and prepared using the Dominion Command Form 800281 (latest edition). The following information is to be included on the application form:
  - a. The membership strength of the Ladies Auxiliary must be shown, as service in a small or large community may have an impact;
  - b. The date and type of meeting where the award was approved, ensuring that a copy of the minutes of the meeting where the application was approved are attached to the application form. The minutes should include the name(s) of the member(s) and the award(s) being applied for. If it is the wish to keep the name(s) of the applicant(s) confidential,

- an 'in camera' provision could be utilized at an Executive Meeting to discuss the application(s). The minutes of the 'in camera' portion of the meeting are to be included with the rest of the Executive Meeting minutes when submitting the application;
- c. The application must be completed, signed and submitted in accordance with any specific Provincial Command rules respecting honours and awards;
  - d. The application must be signed by two senior Ladies Auxiliary Officers, preferably the President and the Secretary;
  - e. When completed, the application, in the number of copies required by the applicable Provincial Command, is to be submitted to that Command;
  - f. An application from a Zone or District must be approved at a properly constituted meeting of the Zone or District, completed, signed and submitted as noted above.
214. The Citation. Care must be taken in preparing the citation. It must be remembered that the members of the Dominion Command Ritual, Awards and Protocol Committee have only the citation on which to base decisions. Therefore, complete details, including dates, must be provided of the outstanding services rendered in the Legion and any community service by the member being recommended, **since the last award**. If awarded, a copy of the citation from Life Membership application would aid the Committee in making their decision.
215. The MSA medal, brooch, plaque, certificate and a distinctive card accompany the award.
216. The MSA can only be awarded once, regardless of the level.

#### **PALM LEAF TO THE MSM AND MSA**

217. The Palm Leaf can only be awarded to a member who has been previously awarded the MSM or MSA. The Palm Leaf recognizes further outstanding service. **Deeds that were recognized when the MSM or MSA was awarded are not considered, as these achievements have been recognized.**

- 218.** When considering a comrade for a Palm Leaf, the criteria to be used to evaluate the activities of the comrade are as shown in Section 204. Obviously, the activities being considered must be at least equal to or exceed those which earned the comrade the MSM or MSA. It is generally considered that a period of 5 years minimum has elapsed between the awarding of an MSM/MSA and the application for a Palm Leaf.
- 219.** Approval of the Palm Leaf is the responsibility of the Dominion Command Ritual, Awards and Protocol Committee.
- 220.** The nomination must be approved at an Executive or General Meeting of the Branch or Ladies Auxiliary to the Branch and prepared using the Dominion Command Form 800281 (latest edition). The following information is to be included on the application form:
- a.** The membership strength of the Branch or Ladies Auxiliary must be shown, as service in a small or large community may have an impact;
  - b.** The date and type of meeting where the award was approved, ensuring that a copy of the minutes of the meeting where the application was approved are attached to the application form. The minutes should include the name(s) of the member(s) and the award(s) being applied for. If it is the wish to keep the name(s) of the applicant(s) confidential, an ‘in camera’ provision could be utilized at an Executive Meeting to discuss the application(s). The minutes of the ‘in camera’ portion of the meeting are to be included with the rest of the Executive Meeting minutes when submitting the application;
  - c.** The application must be completed, signed and submitted in accordance with any specific Provincial Command rules respecting honours and awards;
  - d.** The application must be signed by two senior Branch or Ladies Auxiliary Officers, preferably the President and the Secretary;
  - e.** When completed, the application, in the number of copies required by the applicable Provincial Command, is to be submitted to that Command;
  - f.** An application from a Zone or District must be approved at a properly constituted meeting of the

Zone or District, completed, signed and submitted as noted above.

- 221.** The Citation. Care must be taken in preparing the citation. It must be remembered that the members of the Dominion Command Ritual, Awards and Protocol Committee have only the citation on which to base decisions. Therefore, complete details, including dates, must be provided of the outstanding services rendered in the Legion and any community service, since the last award, by the member being recommended.

A copy of the citation for the previously awarded MSM or MSA must accompany the application for the Palm Leaf. If not available, please explain.

- 222.** The Palm Leaf and plaque constitute the award.
- 223.** The Palm Leaf can only be awarded once, regardless of level.

### **LIFE MEMBERSHIP**

- 224.** Any Ordinary, Associate or Affiliate Voting member may be awarded a Life Membership for outstanding Legion service after ten years of continuous membership. The Life Membership must be recommended by the comrade's Branch and approved by the applicable Provincial Command. The period of membership that must be achieved is 10 consecutive years immediately prior to the date of the nomination. The ten years service does not have to be at the same branch. There is a requirement to pay Dominion and Provincial Command per capita tax as shown in the table that follows, once proof of age has been established to the satisfaction of the Branch. The per capita tax is payable by Branches, in a lump sum payment, for the required number of years, as per the table following Section 225 e.
- 225.** The nomination must be approved at an Executive or General Meeting of the Branch and prepared using the Dominion Command Form 800282 (latest edition). The following information is to be included on the application form:
- a.** The membership strength of the Branch must be shown, as service in a small or large community may have an impact;
  - b.** The date and type of meeting where the award was approved, ensuring that a copy of the minutes of the

meeting where the application was approved are attached to the application form. The minutes should include the name(s) of the member(s) and the award(s) being applied for. If it is the wish to keep the name(s) of the applicant(s) confidential, an ‘in camera’ provision could be utilized at an Executive Meeting to discuss the application(s). The minutes of the ‘in camera’ portion of the meeting are to be included with the rest of the Executive Meeting minutes when submitting the application:

- c. The application must be completed, signed and submitted in accordance with any specific Provincial Command rules respecting honours and awards;
- d. The application must be signed by two senior Branch Officers, preferably the President and the Secretary. The signatures of the Zone and/or District Commander are only required if such Provincial Command requires same;
- e. When completed, the application, in the number of copies required by the applicable Provincial Command, is to be submitted to that Command;

**PER CAPITA TAX TO BE PAID FOR LIFE MEMBERSHIP**

59 years of age and under	15 years per capita tax
60-64 years of age inclusive	10 years per capita tax
65-69 years of age inclusive	7 years per capita tax
70 years of age and over	5 years per capita tax

- 226. A Life Member of the Legion shall be recognized as a Life Member regardless of the place of residence. Upon transferring from one Branch to another, a Life Member may be required to pay Branch dues, but shall not be required to pay either Dominion or Provincial per capita tax.
- 227. The provisions set forth in this section for Life Membership shall not affect the validity of the Life Membership granted to members of The Great War Veterans Association of Newfoundland before the said Association ceased to exist. Those said members shall be and are Life Membership of the Legion.

228. When a Life Membership is granted, the Branch is recognizing a member's outstanding service and devotion to the Purposes and Objects of the Legion. Therefore, the citation accompanying the application must provide complete details (including dates or spans of time) of the outstanding service (which must include service to the Legion and any community service) rendered by the member being recommended for the award.
229. Provincial Commands are the approving authority for Life Membership. A membership card indicating "LIFE", lapel badge a certificate suitable for framing (no longer has to be purchased separately) will be issued by Dominion Command. A Life Member blazer crest and plaque are available through the Legion Supply System.
230. If a member dies between the time a Life Membership is approved by the Provincial Command and submission to Dominion Command, no per capita tax is required. This means that the Branch may still recognize the recipient of the Life Membership posthumously, by presenting the deceased member's family with a Life Membership Certificate.

---

**Note: A branch will not be refunded if a Life Member dies after the per capita tax has been submitted to Dominion Command.**

---

### **HONORARY LIFE MEMBERSHIP**

231. Any person may be granted an Honorary Life Membership by the awarding of a Life Membership into the Royal Canadian Legion by the Dominion Executive Council for outstanding national service. No per capita tax shall be payable in connection with HONORARY Life Membership. A lapel pin and certificate that is suitable for framing are provided by Dominion Command.

### **CERTIFICATE OF MERIT**

232. A certificate of Merit may be granted to Legion members and members of the Ladies' Auxiliaries in recognition of service rendered to or on behalf of the Legion. There are three types of these certificates:
  - a. Dominion level which are authorized by Dominion Command Ritual & Awards and Protocol Committee



and issued by Dominion Command; applications are initiated at Dominion Command level and are approved by the Senior Elected Officers;

- b. Provincial level (including District and Zone) which are obtained through Provincial Command;
- c. Branch level which are obtained through Provincial Command or Dominion Command.

**233.** The use of Certificates of Merit is encouraged at the Provincial Command and Branch level in the following circumstances:

- a. When it is desired to honour a member for service which is considered to be above that which might be expected of an officer or member, but not sufficient to warrant a recommendation for a Life Membership or MSM;
- b. As a means to recognize contributions made by members in the intervening years before they would be eligible for consideration for a Life Membership or the Meritorious Service Medal;
- c. To recognize a particular service rendered by a member to a Command or Branch where the service may have been of short duration, but of such a high order, that some form of recognition is considered necessary.

**234.** The Certificate of Merit is obtained through the Legion Supply System,

Branch level - English, 700133, French, 700159;

Provincial Command level - English, 700132, French, 700158.

**235.** Certificates approved by Dominion Command are authorized by the Dominion Command Ritual, Awards and Protocol Committee.

### **CERTIFICATE OF APPRECIATION**

**236.** A Certificate of Appreciation may be awarded to Legion members and members of the Ladies Auxiliary for services provided to the Legion.

**237.** Certificates of Appreciation may be awarded by Branches, Zones, Districts, Provincial Commands and Dominion Command as deemed appropriate.

The award is in the form of a certificate that is suitable for framing.

### **LEGIONNAIRE OF THE YEAR AWARD**

- 238.** The Legionnaire of the Year Award is another award available to recognize the hard work of many volunteers within our Branches. Legion Branches have dedicated members who volunteer countless hours each year towards their success. Branches are encouraged to choose one of their members each year from amongst these valued volunteers to recognize them as ‘Legionnaire of the Year.’

The criteria for this award is left to the discretion of each individual Branch. A high quality plaque for such an occasion is available through the Dominion Command Legion Supply.

### **50 YEAR LONG SERVICE MEDAL**

- 239.** The 50 Year Long Service Medal may be awarded to Legion members and members of the Ladies Auxiliary who have completed fifty years of membership in The Royal Canadian Legion. For the purposes of this medal a person’s service includes that in the Canadian Legion of the British Empire Ex-Services League and The Great War Veterans Association. The medal may only be awarded on the recommendation of the member’s Branch.
- 240.** The 50 Year Long Service Medal can be enhanced every 5 years with incremental bars exclusively designed for this award for 55 years, 60 years, 65 years, etc.

## **AWARDS TO OTHER THAN LEGION MEMBERS**

### **FRIENDSHIP AWARD**

- 241.** The Friendship Award exists to honour and recognize individuals and organizations who have rendered assistance, service or cooperation to the Legion beyond that which could normally be anticipated or expected.
- 242.** The award may be bestowed upon other veterans organizations such as the American Legion; organizations, groups and service clubs within the community; and individuals who are members of

these organizations. Although this award is intended to be awarded to other than Legion members, should an extraordinary circumstance arise, it may be awarded to a Legion member at the discretion of the Dominion President.

- 243.** The award consists of either of the following:
- a. A wall plaque signed by the Dominion President; or,
  - b. A medal and a certificate, signed by the Dominion President that is suitable for framing.
- 244.** Applications for the award may originate at the Branch, Provincial Command or Dominion Command level. The approving authority for Branch applications is the applicable Provincial Command.
- 245.** The Citation. The information justifying the award must be detailed and precise ensuring that the cooperation, assistance or service provided is fully documented.
- 246.** Applications. Applications for the Friendship Award are to be made on Dominion Command form 800753 (latest edition). Areas of the form that do not apply are to be marked “not applicable”.

### **CERTIFICATE OF MERIT**

- 247.** A Certificate of Merit may be granted to organizations, groups or persons outside of the Legion in recognition of service(s) rendered to or on behalf of the Legion. See Sections 232-233.

### **CERTIFICATE OF APPRECIATION**

- 248.** A Certificate of Appreciation may be awarded by any level to individuals, companies, groups, etc. for special service(s) rendered to the Legion. See Section 236.

### **MEDIA AWARD**

- 249.** The Media Award exists to recognize the media - newspapers and radio and television stations - that have supported the Legion’s work within the community. The award may be presented to media outlets or media personnel at the Branch, Zone, District and Provincial Command levels.
- 250.** The approving authority for Branch applications is the applicable Provincial Command.

251. The Citation. The information justifying the award must be detailed and precise ensuring that the cooperation, assistance or service provided is fully documented.
252. Applications. Applications for the Media Award are to be made on Dominion Command form 800464 (latest edition). Areas of the form that do not apply are to be marked “not applicable”.

### **FOUNDERS AWARD**

253. The Founders Award exists to honour and recognize individuals or organizations who have made significant contributions and extraordinary achievement and accomplishments in upholding the ideals and principles of the Royal Canadian Legion, and in an area that exemplifies and advances our purposes and objects in the spirit and vision of our founding members.
254. The award consists of the following:
  - a. a crystal etched award style design incorporating the poppy/maple leaf symbol mounted against a stone base;
  - b. a framed citation signed by the Dominion President.
255. Nominations. Nominations for the award may originate at the Branch, Provincial Command or Dominion Command level. Commands may forward nominations to Dominion Command. Nominations are to be submitted to recognize the achievements of those from outside the Legion.
256. The citation. The information justifying the award must be detailed and precise ensuring that contributions and extraordinary achievements and accomplishments of the individual or organization must be of exceptional high importance or prominence.
257. The selection of the recipient(s) for this award rests solely with the Dominion President. The name(s) of the recipients will be provided to the Dominion Command Ritual, Awards and Protocol Committee for notification and presented to the Dominion Executive Council for ratification.

**258.** This award is to be presented when it is determined that an achievement warrants such recognition. It will be presented to the recipient(s) at a Dominion Convention or other significant Legion event.

## **AWARDS: PAST LEGION SERVICE**

### **PAST OFFICE MEDALS**

**259.** As a means of recognizing the service of comrades to the Legion a method of acknowledging their dedication to our Purposes and Objects was implemented and has been in place since the organization was formed. The recognition of these comrades is achieved through the awarding of Past Office medals and bars.

**260.** Eligibility. To be eligible for a Past Office award, the member must complete one full term of office. However, should the term of office not be completed, the member may, providing at least 50% of the term plus one day has been completed, be eligible to receive the award. The circumstances under which this provision applies are:

- a.** An appointment to another office; or,
- b.** The inability of the comrade to carry on with the duties due to a transfer, relocation, ill health or similar valid reason.

**261.** Any member, during the term, who has been appointed to an office or replaced an office holder and completes at least 50% of the term plus one day, is entitled to a Past Office Medal.

**262.** A member is eligible for only one Past Office medal at any one level of the Legion regardless of the number of offices held at that level. The other offices that the member may hold are recognized through the provision of “bars” to the one Past Office medal.

**263.** All, Ordinary, Associate and Affiliate-Voting members are eligible for Past Office awards.

### **BARS TO PAST OFFICE MEDALS**

**264.** A member is only eligible for one bar for each office held, even though the member may have held the office for more than one term.

265. A member holding a Past President or Past Commander medal is eligible for the Maple Leaf bar to this medal upon completion of a complete second term in office. The terms do not have to be consecutive.
266. Members of Dominion Executive Council receive a Dominion Past Office Medal with a Dominion Bar, a Bar for their elected office, and a Committee Bar for the Standing Committee that they Chair or serve. This is to be received on completion of one full term on Council.
267. Members of Dominion Executive Council appointed to Chair a Dominion Command Standing Committee who are not a voting member of Dominion Executive Council, receive a Dominion Past Office Medal with a Dominion Bar, and a Committee Bar for the Standing Committee that they Chair. This is to be received on completion of one full term on Council.
268. Dominion Command Standing Committee Members who are not and have not been members of Dominion Executive Council receive a Dominion Past Committee Member Medal with a Dominion Bar, and a Committee Bar for the Standing Committee that they serve on. This is to be received on the completion of one full term on the Standing Committee on which they served.

#### **PAST PRESIDENT/COMMANDER MEDAL**

269. A member is eligible to receive only one “Past President/Commander” medal for service in a President/Commander position at each level of the Legion - a Branch or Post, Provincial Command and Dominion Command as applicable.

#### **BRANCH/L.A. SERVICE MEDAL**

270. This medal is awarded to members of the Branch/Post and of Ladies Auxiliaries to the Branch to recognize the significant work accomplished by their many members, outside of, or prior to their acceptance to leadership positions. The qualification for the awarding of the Service Medal is to be a significant level of service provided by the member to their Branch/Post or L.A. Although this medal is intended to be awarded to members who have not been members of the Branch/

Post or L.A. Executive, it may also be awarded in addition to any awards/medals previously received by the member for exemplary service over and above any responsibilities required for any offices held. However, holding an Executive position does not in itself justify the award, as once a person assumes a position, the member is expected to perform the duties of that position to the best of their ability. Recipients of this medal are also permitted to wear any earned past office Legion bars on this medal. This medal is to be senior to all Commemorative Medals and junior to the Branch/Post and/or L.A. Past Office Medal. The recommending and approving authority is to be the Branch/Post or L.A. Executive Committee and/or the General Membership. It is not the intent to have the L.A. present an L.A. Service medal to a Branch member or for a Branch to present an L.A. member with a Branch Service medal.

### **LAPEL BADGES**

271. A member may wear only one Legion lapel badge on a Legion blazer.
272. All, Ordinary, Associate and Affiliate members are entitled to Legion Long Service lapel badges, in five year increments, which are available through the Legion Supply System.
273. A long service badge may be awarded at any time during the year the member is entitled to receive the award.

### **APPLICATIONS - PAST OFFICE AWARDS**

274. Past Office awards, medals or bars, are controlled by the applicable Branch, Zone, District or Command.

### **LISTING - PAST OFFICE AWARDS**

275. All Past Office awards and their description are shown on pages 35-44 of this manual. They may also be found in the Legion Supply Catalogue and ordered directly through the Supply Department.

## AWARDS IN RECOGNITION OF MERITORIOUS OR OUTSTANDING SERVICE

AWARD	ORIGINATING LEVEL	RECOMMENDING AUTHORITY	APPROVING AUTHORITY	REMARKS
Meritorious Service Medal (MSM)	Branch/Post Zone District Provincial Command Dominion Command	Provincial Command Provincial Command Provincial Command Provincial Command Dominion Command	Dominion Command Dominion Command Dominion Command Dominion Command Dominion Command	Applications may originate at any level, but only one MSM may be awarded to a person and the approving authority is the Dominion Command Ritual & Awards and Protocol Committee.
Meritorious Service Award (MSA) Ladies Auxilliary (L.A.)	Branch (L.A.) Zone (L.A.) District (L.A.) Provincial Command (L.A.)	Provincial Command Provincial Command Provincial Command Provincial Command	Dominion Command Dominion Command Dominion Command Dominion Command	Applications may originate at any level, but only one MSA may be awarded to a person and the approving authority is the Dominion Command Ritual & Awards and Protocol Committee.
Palm Leaf to Meritorious Service Medal	Branch/Post Zone District Provincial Command Dominion Command	Provincial Command Provincial Command Provincial Command Provincial Command Dominion Command	Dominion Command Dominion Command Dominion Command Dominion Command Dominion Command	Applications for the Palm Leaf may originate at a different level from the one at which the MSM was granted. The approving authority is the Dominion Command Ritual & Awards and Protocol Committee.



## AWARDS IN RECOGNITION OF MERITORIOUS OR OUTSTANDING SERVICE

AWARD	ORIGINATING LEVEL	RECOMMENDING AUTHORITY	APPROVING AUTHORITY	REMARKS
Palm Leaf to Meritorious Service Award	Branch (L.A.) Zone (L.A.) District (L.A.) Provincial Cmd (L.A.) Dominion Command	Provincial Command Provincial Command Provincial Command Dominion Command	Dominion Command Dominion Command Dominion Command Dominion Command	Applications for the Palm Leaf may originate at a different level from the one at which the MSA was granted. The approving authority is the Dominion Command Ritual & Awards and Protocol Committee.
Life Membership	Branch/Post	Branch/Post	Provincial Command	After approval by Provincial Command, the application form is sent to Dominion Command for issue of a Life Membership card & lapel badge.
Honorary Life Award	Dominion Executive Council	Dominion Command	Dominion Command	Awarded for national service.
Certificate of Merit	Branch/Post Zone District Provincial Command Dominion Command	Branch/Post Zone District Provincial Command Dominion Command	Branch/Post Zone District Provincial Command Senior Elected Officers of DEC	Certificates of Merit are awarded to organizations, groups, persons outside of the Legion, members of the Legion and members of the Ladies Auxiliaries in recognition of service rendered to or on behalf of the Legion.

## AWARDS IN RECOGNITION OF MERITORIOUS OR OUTSTANDING SERVICE

AWARD	ORIGINATING LEVEL	RECOMMENDING AUTHORITY	APPROVING AUTHORITY	REMARKS
Certificate of Appreciation	Branch/Post Zone District Provincial Command Dominion Command	Branch/Post Zone District Provincial Command Dominion Command	Branch/Post Zone District Provincial Command Dominion Command	Certificates of Appreciation are awarded to organizations, groups, persons outside of the Legion, members of the Legion and members of the Ladies Auxiliaries in recognition of service rendered to or on behalf of the Legion.
Long Service Medal	Branch/Post	Branch/Post	Branch/Post	Awarded to those with 50 years of membership in R.C.L.
5 year increment bars to Long Service Medal	Branch/Post	Branch/Post	Branch/Post Provincial Command	Awarded to those with 50 years of continuous membership in R.C.L.
Branch/L.A. Service Medal	Branch/Post	Branch/Post	Branch/Post	Awarded to members for exemplary service outside of or prior to service on Branch/L.A. Executives. Also see Section 272.

## AWARDS IN RECOGNITION OF MERITORIOUS OR OUTSTANDING SERVICE

AWARD	ORIGINATING LEVEL	RECOMMENDING AUTHORITY	APPROVING AUTHORITY	REMARKS
Friendship Award	Branch/Post	Branch/Post Zone District Provincial Command Dominion Command	Provincial Command Provincial Command Provincial Command Provincial Command Dominion Command	Awarded to persons or organizations outside the Legion. Although this award is intended to be awarded to other than Legion members, should an extraordinary circumstance arise, it may be awarded to a Legion member at the discretion of the Dominion President.
	Zone			
	District			
	Provincial Command			
Founders Award	Branch/Post	Branch/Post Zone District Provincial Command Dominion Command	Dominion President Dominion President Dominion President Dominion President Dominion President	Awarded to individuals or organizations that have made extraordinary achievement and accomplishments in upholding the ideals and principles of the Royal Canadian Legion.
	Zone			
	District			
	Provincial Command			
Media Award	Branch/Post	Branch/Post Zone District Provincial Command Dominion Command	Provincial Command Provincial Command Provincial Command Provincial Command Dominion Command	Awarded to newspapers, radio and T.V. stations or media personnel, which have performed valuable service to the Legion.
	Zone			
	District			
	Provincial Command			

## PAST LEGION SERVICE

AWARD	ORIGINATING LEVEL	RECOMMENDING AUTHORITY	APPROVING AUTHORITY	REMARKS
Past Office Medals and Bars	Branch/Post	Branch/Post Zone District Provincial Command Dominion Command	Branch/Post Zone District Provincial Command Dominion Command	Awarded to Legion members for Past Offices held at the various levels within The Legion.
	Zone			
	District			
	Provincial Command			

## MEDALS, BARS, LAPEL BADGES AND CERTIFICATES

### GENERAL

A bar for leadership is available for various levels within the Legion. Leadership encompasses the Leadership, Training and Development involved in the development of leaders of our organization at all levels. The Leadership bar is intended for chairmen of all training, development and leadership committees.

At various levels of our organization, bars are available for Honourary Treasurer, Honourary Secretary and Honourary Secretary/Treasurer. They are for appointed positions. The bar for Secretary, Treasurer and Secretary Treasurer are for elected positions

The illustrations that follow depict the medals, bars, lapel badges and certificates that are available for members, the Ladies Auxiliary and presentation to the general public. The illustrations show the product number, the name and an image of the item.

The United States Commands became an Eastern and Western Zone of USA respectively in June 2000 at the 38th Dominion Convention held in Halifax, Nova Scotia. The branches/posts in these two zones have the option of using either word; therefore, the medals and bars for service at a branch or post will continue to be used.

### MERITORIOUS SERVICE MEDAL AND AWARD

MERITORIOUS SERVICE MEDAL SET - 100205			
 <p>A blue ribbon with gold stripes and a gold medal featuring a red maple leaf and the words 'FOR MERIT' and '1952'.</p>	 <p>A gold lapel badge with a red maple leaf and the words 'FOR MERIT' and '1952'.</p> <p><b>Lapel Badge</b> 100329</p>  <p>A small white card with a gold border, featuring the Royal Canadian Legion logo and the text 'THE MERITORIOUS SERVICE MEDAL'.</p> <p><b>Card</b> 100343</p>	 <p>A white certificate with a gold border, featuring the Royal Canadian Legion logo and the text 'THE MERITORIOUS SERVICE MEDAL'.</p> <p><b>Certificate</b> 100296</p>	 <p>A wooden plaque with a gold border, featuring the Royal Canadian Legion logo and the text 'MERITORIOUS SERVICE' and '1952'.</p> <p><b>Plaque</b> 900118</p>
MERITORIOUS SERVICE MEDAL continued on next page			

MERITORIOUS SERVICE MEDAL - contined from previous page

MERITORIOUS SERVICE AWARD SET - 100234


	 Badge 100356	 Brooch 100295		
Medal 100206	 Card 100342		Certificate 100298	Plaque 900213

PALM LEAF KIT - For the Meritorious Service Medal and Award - 100375



	Palm Leaf 100204		Plaque 10375A
---	---------------------	---	------------------



PAST SERVICE - DOMINION COMMAND

<p>PAST PRESIDENT MEDAL</p>	<p>PAST OFFICER MEDAL</p>
	
Past President Operational Stress Injury Medal (O.S.I.)	Past Officer Operational Stress Injury Medal (O.S.I.)









Bar - Operational Stress Injury

**PAST SERVICE - DOMINION COMMAND**

DOMINION PRESIDENT	
 <p>Past President Medal 800105</p>	 <p>Lapel badge Dominion Past President 800100</p>

PAST SECTION PRESIDENTS	
	<p>Past President Tuberculosis Veterans Medal (T.V.S.) 800120</p>
	 <p>Bar - T.V.S. 800121</p>

PAST OFFICE
 <p>Past Office Medal 800106</p>

BARS - PAST OFFICE	
	1st Vice President 800114
	Vice President 800119
	Treasurer 800115
	Chair 800116
	Vice-Chair (this elected position was retired at the 2000 Dominion Convention) 800117
	Chaplain 800118
	Councillor 800125

ALL DOMINION OFFICES
 <p>Bar - Dominion Offices - 800691</p>
<p>Committee Bars - All Dominion Standing Committee Members are issued a Committee bar for the committee they chair or serve on. Bars will be struck as deemed appropriate.</p>

ALL DOMINION OFFICES
 <p>Past Committee Member medal 800104</p>

## PAST SERVICE - PROVINCIAL COMMANDS

### PAST PROVINCIAL PRESIDENT MEDAL SET - 100150



Set includes medal and lapel badge



Lapel Badge  
100119



Bar - Provincial Past President - 100151

### STATE PAST COMMANDER MEDAL SET - 100152



Set includes medal and lapel badge



Lapel Badge  
100124



Bar - State Past Commander  
100151

### PROVINCIAL PAST OFFICE



Past Office Medal  
100154

### BARS - PROVINCIAL OR STATE PAST OFFICE

**1st VICE PRESIDENT**

1st Vice-President  
100155

**2nd VICE PRESIDENT**

2nd Vice-President  
100308

**VICE PRESIDENT**

Vice-President  
100156

**HON. SECRETARY**

Honorary Secretary  
100157

**HON. TREASURER**

Honorary Treasurer  
100158

**CHAIRMAN**

Chair  
100159

**VICE CHAIRMAN**

Vice-Chair  
100160

**COUNCILLOR**

Councillor  
100161

**CHAPLAIN**

Chaplain  
100165

**SERVICE OFFICER**

Service Officer  
100166

**SECRETARY TREASURER**

Secretary-Treasurer  
100167

**EXECUTIVE COMMITTEE**

Executive Committee  
100168

**SECRETARY**

Secretary  
100312

**TREASURER**

Treasurer  
100313

**VICE COMMANDER**

Vice-Commander  
100364

**PROVINCIAL**

Provincial  
100407

**PUBLIC RELATIONS**

Public Relations  
100416













**PARADE COMMANDER**

Parade Commander  
100493





**COLOUR SERGEANT**

Colour Sergeant  
100499

BARS - PROVINCIAL OR STATE PAST OFFICE  
continued on next page

BARS - PROVINCIAL OR STATE PAST OFFICE - contined from previous page			
Sports 100417			Youth Education 100418
Leadership 100441			Veterans Service 100442
Seniors 100443			Track & Field 100444
Membership 100446			Poppy 100448
Constitution and Laws - 100462			Honours and Awards - 100465
Ways and Means - 100566			Bursary








### LADIES' AUXILIARY - PAST SERVICE PROVINCIAL COMMANDS















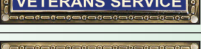

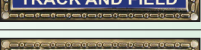
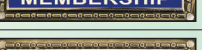


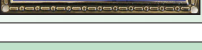
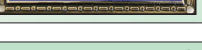
<b>PROVINCIAL PAST PRESIDENT L.A. MEDAL SET - 100207</b>	<b>PROVINCIAL PAST OFFICE L.A.</b>
 <p>Set includes medal and lapel badge.</p>	 <p>Past Office Medal 100209</p>
 <p>Lapel Badge 100149</p>	
 <p>Bar - Provincial Past President L.A. - 100151</p>	

BARS - PROVINCIAL PAST OFFICE L.A.			
1st Vice-President 100210			Vice-President 100211
Honorary Treasurer 100212			Honorary Secretary 100213
Chair 100214			Vice-Chair 100215
Secretary-Treasurer 100216			Executive Committee 100217
Secretary 100319			Treasurer 100320
Councillor 100327			Sports 100474











**PAST SERVICE - DISTRICTS OR ZONES**

<p><b>DISTRICT PAST COMMANDER MEDAL SET</b> 100171</p>	<p><b>ZONE PAST COMMANDER MEDAL SET</b> 100180</p>	<p><b>DISTRICT OR ZONE PAST OFFICE</b></p>
 <p>Set includes medal and lapel badge.</p>	 <p>Set includes medal and lapel badge.</p>	
 <p>Lapel Badge 100145</p>	 <p>Lapel Badge 100144</p>	
		<p>Past Office Medal 100173</p>
<p>Bar - District Past Commander 100172</p>	<p>Bar - Zone Past Commander 100172</p>	

BARS - DISTRICT OR ZONE PAST OFFICE		
District 100174		 Deputy Commander 100177
Zone 100175		 Honorary Secretary 100176
Chair 100178		 Executive Committee 100179
Secretary 100314		 Treasurer 100315
Honorary Treasurer 100316		 Sergeant at Arms 100395
Public Relations 100413		 Sports 100414
Youth Education 100415		 Leadership 100437
Veterans Service 100438		 Seniors 100439
Track & Field 100440		 Membership 100445
Poppy 100447		 Constitution and Laws - 100463
Honours and Awards - 100466		 Vice Commander 100364

BARS - DISTRICT OR ZONE PAST OFFICE continued on next page

**BARS - DISTRICT OR ZONE PAST OFFICE - continued from previous page**

1st Vice-Commander (U.S. only) - 100162			Finance Officer 100163
Adjutant 100164			Parade Commander 100492
Colour Sergeant 100498			Chaplain 100554
Ways and Means 100565			Bursary








**LADIES AUXILIARY - PAST SERVICE - DISTRICTS OR ZONES**

**DISTRICT OR ZONE  
PAST OFFICE L.A.**



Past Office  
Medal  
100218

**BARS - DISTRICT OR ZONE PAST OFFICE L.A.**

	Zone 100219
	District 100220
	Commander 100350
	Secretary 100381
	Treasurer 100383
	Deputy Commander 100404
	Sports 100473

**PAST SERVICE - BRANCHES AND POSTS**

**BRANCH PAST PRESIDENT  
MEDAL SET - 100182**



Set includes  
medal and lapel  
badge



Lapel Badge  
100120



Bar - Branch Past President  
100183

**POST PAST COMMANDER  
MEDAL SET - 100184**



Set includes  
medal and lapel  
badge



Lapel Badge  
100124






































Bar - Post Past Commander  
100183





**BRANCH OR  
POST  
PAST OFFICE**





Past Office  
Medal  
100186

BARS - BRANCH OR POST PAST OFFICE		
1st Vice-President 100187		 2nd Vice-President 100328
3rd Vice-President 100347		 Vice-President 100188
Honorary Treasurer 100189		 Honorary Secretary 100190
Honorary Secretary- Treasurer - 100191		 Chair 100192
1st Vice-Commander (U.S. only) - 100193		 2nd Vice-Commander (U.S. only) - 100194
3rd Vice- Commander (U.S. only) - 100195		 Finance Officer (U.S. only) 100196
Adjutant (U.S. only) 100197		 Chaplain 100198
Sergeant at Arms 100199		 Service Officer 100200
Secretary-Treasurer 100201		 Executive Committee 100202
Secretary 100317		 Treasurer 100318
Membership 100370		 Poppy 100396
Public Relations 100410		 Sports 100411
Youth Education 100412		 Leadership 100432
Veterans Service 100433		 Seniors 100434
Track and Field 100435		 Constitution and Laws 100461
Honours and Awards 100464		 Parade Commander 100491
Colour Sergeant 100497		 Ways and Means 100564
Bursary		

## LADIES' AUXILIARY - PAST SERVICE - BRANCHES AND POSTS

<p style="text-align: center;"><b>BRANCH OR POST PAST PRESIDENT, L.A. MEDAL SET - 100221</b></p> <div style="display: flex; justify-content: space-around;"> <div style="text-align: center;">  <p>Set includes medal and lapel badge</p> </div> <div style="text-align: center;">  <p>Lapel Badge 100136</p> </div> </div>	 <p>Bar - Branch or Post Past President L.A. 100183</p>	<p style="text-align: center;"><b>BRANCH OR POST PAST OFFICE, L.A.</b></p> <div style="text-align: center;">  <p>Past Office Medal 100223</p> </div>
---	--	---

### BARS - BRANCH OR POST PAST OFFICE, L.A.

<p>1st Vice-President 100224</p>			<p>2nd Vice-President 100348</p>
<p>3rd Vice-President 100398</p>			<p>Vice-President 100225</p>
<p>Honorary Treasurer 100226</p>			<p>Honorary Secretary 100227</p>
<p>Chair 100228</p>			<p>Honorary Secretary-Treasurer - 100229</p>
<p>Sgt.-at-Arms 100230</p>			<p>Secretary-Treasurer 100231</p>
<p>Executive Committee - 100232</p>			<p>Secretary 100321</p>
<p>Treasurer 100322</p>			<p>Deputy Commander 100346</p>
<p>Membership 100384</p>			<p>Sports 100428</p>
<p>Ways and Means 100570</p>			

## PAST ANNIVERSARY MEDALS

<p style="text-align: center;"><b>50TH ANNIVERSARY</b></p> <div style="display: flex; justify-content: space-around;"> <div style="text-align: center;">  </div> <div> <p>Issued only during the Golden Anniversary Year (no longer available)</p> </div> </div>	<p style="text-align: center;"><b>50TH ANNIVERSARY, L.A.</b></p> <div style="display: flex; justify-content: space-around;"> <div style="text-align: center;">  </div> <div> <p>Issued only during the Golden Anniversary Year (no longer available)</p> </div> </div>	<p style="text-align: center;"><b>DIAMOND JUBILEE</b></p> <div style="display: flex; justify-content: space-around;"> <div style="text-align: center;">  </div> <div> <p>Issued only during the Diamond Jubilee Year (no longer available)</p> </div> </div>
---	---	---

PAST ANNIVERSARY MEDALS continued on next page

**PAST ANNIVERSARY MEDALS**  
continued from previous page

**90TH ANNIVERSARY**



Issued only during the 90th Anniversary Celebrations

**150TH ANNIVERSARY**



Issued only during the 150th Anniversary (no longer available)

**MISCELLANEOUS AWARDS**

**50 YEARS SERVICE MEDAL - 100235**



**50 YEARS SERVICE L.A. MEDAL - 100369**



**BARS - 50 YEARS SERVICE MEDAL, LEGION AND L.A.**



55 Years  
100481



60 Years  
100482



65 Years  
100483



70 Years  
100484



75 Years  
100485



80 Years  
100486

**BRANCH SERVICE MEDAL - 100537**



**L.A. SERVICE MEDAL - 100538**



**CERTIFICATES**

**CERTIFICATE OF MERIT**



**Dominion Level**  
800107



**Provincial Level**  
700132



**Branch Level**  
700133

**CERTIFICATES continued on next page**

CERTIFICATES continued from previous page

CERTIFICATE OF APPRECIATION



All Levels  
700207

LIFE MEMBER AWARD CERTIFICATE



Branch Level  
100311

AWARDS FOR OTHER THAN LEGION MEMBERS

FRIENDSHIP AWARD



Plaque  
(no medal)  
100233

OR

FRIENDSHIP AWARD MEDAL SET - 100310



Certificate  
700150

Set includes medal  
and certificate

MEDIA AWARD



Plaque  
900146

CADET/JUNIOR RANGER MEDAL



LEGIONNAIRE OF THE YEAR AWARD



Plaque  
700618

# AWARDS

## CANADIAN HONOURS AND AWARDS

### GENERAL

276. The Government of Canada has created a system of Canadian Honours and Awards, to reward those deserving Canadians who have enriched the lives of others or who have placed themselves at risk to save or protect the lives of other human beings. All Legion members are eligible to receive these honours.

### PURPOSE

277. The purpose of this section of the manual is to assist members of The Royal Canadian Legion in the preparation and submission of nominations for such Canadian Honours to be awarded to Legion Members for their service to, or in representation of Canada. The purpose of this section is also to make our members aware of the various Canadian Honours and Awards available for deserving members.

278. The Ritual and Awards Committee is available to assist in the preparation and submission of nominations for these Canadian Honours. This Committee's purpose is to be instructive and supportive of all submissions that may be received through the Legion and to ensure that Legion volunteers are recognized for their good works in the wider community.

### HONOURS

279. Canadian Honours and Awards are awarded to recognize extraordinary achievement and the recipients of these honours must have performed an act of service which is truly outstanding. The following are just a few of the most notable honours available:

- a. Decorations for Bravery
- b. Meritorious Service Decorations
- c. Order of Canada
- d. Sovereign's Medal For Volunteers
- e. Minister of Veterans Affairs Commendation

# ORDERS

## THE ORDER OF CANADA

### GOVERNOR GENERAL'S AWARDS

**280.** For a complete list of the Canadian Honours and Awards available through the office of the Chancellery of Honours at Rideau Hall, visit their website at **www.gg.ca** under the honours section.

#### NOMINATION PROCESS

**281.** Nominations may be initiated at any level of the Legion organization. While nominations for Canadian Honours and Awards may be submitted by any person or group directly to the approving authority, (Rideau Hall or Veterans Affairs Canada (VAC)) without being vetted by any intermediate agency, experience obtained from both the Department of National Defence and the RCMP has proven that an 'in house' reviewing system greatly enhances the recognition of the nominations. It is for this reason that Dominion Command will accept nominations for such awards through the Legion Honours and Awards system for review.

**282.** Any person or group is welcome to nominate a deserving individual as possible candidate for appointment to the **Order of Canada**, or as candidate for the **Decorations for Bravery, Meritorious Service Decorations** or **Governor General's Sovereign's Medal For Volunteers**.

Nominations presented to the Chancellery of Honours that meet the eligibility criteria are studied thoroughly. They are then reviewed by an independent committee that makes its recommendation to the governor general.

**283.** Recipients of Canadian Honours and Awards are limited and not everyone nominated is necessarily selected. It is therefore important that as much background information as possible is given by the nominator as to the worthiness of the candidate. Relevant biographical information should be approximately 500 words and include the impact that the applicant has made within his or her community and organization. It should



be noted that it is a baseline principle of Canadian Honours policy that individuals should not receive duplicate recognition for the same accomplishment.

## **NOMINATION FORMS**

**284.** Nomination forms may be obtained from The Chancellery of Honours at Rideau Hall at **www.gg.ca** or by calling 1-800-465-6890 for all but the VAC Minister's Commendation which may be found at the VAC website: **www.veterans.gc.ca**. Nomination forms for the VAC Minister's Commendation may also be picked up at any VAC district or regional office.

## **ENDORSEMENT**

**285.** All nominations require the name of the individual being nominated and the name of the nominator. In addition, a letter from an organization or individual supporting the nomination is to be included with the application. These persons will be contacted by the approving authority at Rideau Hall or VAC. It is important to understand that the Canadian Honours and Awards system applies to all Canadians and care must be taken by Legion nominators so that submissions are not viewed by the approving authority as having an undue bias towards our members. For this reason it is strongly recommended that, when possible, supporting endorsements and documents of the nomination should be provided from sources outside of the Legion.

## **PRIME MINISTER AWARDS**

**286.** Further Canadian volunteer awards are also available to deserving Legion members through the office of the Prime Minister. Application forms and information concerning these awards may be found at **www.pm.gc.ca**.

In any organization, the observance of established normalities of protocol enhances and promotes the image of the organization. Given the autonomous nature of the Royal Canadian Legion, a set of recommended protocol guidelines, consistently applied across all levels of our organization, will bring recognition and respect.

Protocol is essentially the observance of official formality and etiquette. It is centuries old and modern as today. It is based on human understanding and the experience of interrelationships and provides stability and dignity in the conduct of affairs between people and nations. When applied to any situation at any level, protocol is the rule of observing etiquette and adhering to the order of precedence and correct procedure. It considers official ceremonies, privileges and ensures proper recognition and respect for position and office.

In this section of the manual, we include Legion Meetings, Order of Precedence, Parades, Banquets and Protocol at Functions. Other protocol regarding such items as Legion Dress, Initiation of Members, Installation of Officers, Ceremonies and Events, Legion Funerals, Flags and Colour Parties etc., can be found in other sections of this manual.

## LEGION MEETINGS

### THE SOVEREIGN'S PICTURE

- 301. Displaying the Picture.** It is the mandatory to display pictures of the Sovereign in a place of honour in Legion halls and on formal occasions such as a convention.
- 302.** The picture is to be fixed to the centre of the wall directly behind the chair that the Chair occupies during a meeting. Should this position not be practical, the picture is to be fixed to the wall that can be described as the wall of the room opposite the Chair. A picture of the Sovereign may also be placed at the back of the hall in addition to the one affixed to the centre of the wall directly behind the Chair. This picture should be fixed to the wall centred in the same position as the one located behind the Chair at the front of the hall. In doing

so, this will eliminate those at the head table and on the stage of the hall from doing an about turn during closing ceremonies.

- 303.** Should a picture of the consort be displayed, this picture and the picture of the Sovereign will be centred on the selected wall. The two pictures are to be displayed at the same level and the picture of the Sovereign will be on the left when looking at the two pictures.

### **INDIGENOUS LAND ACKNOWLEDGMENT**

- 304.** To acknowledge that the Land on which we gather today is the traditional unceded territory of Indigenous Peoples.
- a.** Dominion Command will include Indigenous Land Acknowledgment in the opening ceremonies for all Dominion Command meetings held in/from the National Capital Region under any format including virtual type.
  - b.** Dominion Command will include Indigenous Land Acknowledgment in the opening ceremonies for all Dominion Command Conventions based on the location and territory where the Convention is being held.
  - c.** All Provincial Commands and Branches will include Indigenous Land Acknowledgment in the opening ceremonies for conventions, commemorative ceremonies, and all formal meetings of any type, based on the location of where the event is hosted.

### **OPENING CEREMONY**

- 305. Emblems.** In addition to the above, the emblems of the Legion shall be suitably displayed as follows:
- a.** The poppies in a bowl in front of the chair;
  - b.** The Legion badge on the front of the lectern;
  - c.** The torch where it is plainly visible.
- 306. Colour Party.** The Colour party shall be in a position of readiness at the rear of the hall.

**307. Opening Ceremony.** The text that follows is the Ritual for the Opening Ceremony.

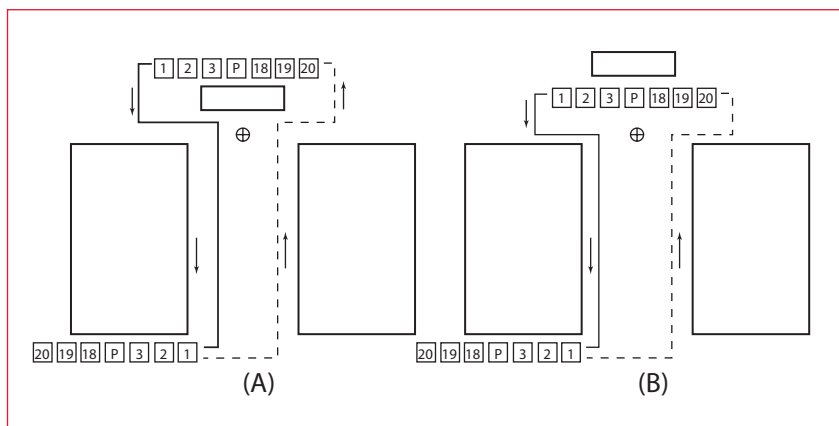
**THE CHAIR:**

**The meeting will stand at attention.**

**Sergeant-at-Arms, march on the Colours.**

*(For the details of colour party procedure, see Figure 3-1)*

**We will now sing our national anthem.**



**Figure 3-1 — Parading of Colours at Legion Meetings**

**Before we proceed to the consideration of the business which has brought us together, let us pause to think reverently of those of our comrades who by sea, by land and in the air, laid down their lives for their Sovereign and country. Their sacrifice will ever inspire us to labour on, to the end that those who survive and need our aid may be assured of assistance, and that the country in which we live, and for which they died may ever be worthy of the sacrifice they made.**

**During The Silence, we will remember our fallen comrades and those who have passed on since we last gathered together. (The names of the persons are to be spoken)**

**LAST POST** *(optional).*

**THE SILENCE**

**LAMENT** *The playing of the Lament is optional; however, if played it is to occur after The Silence.*

**Rouse** *(optional).*

**308. The Act of Remembrance.** The text that follows is the Ritual for the Act of Remembrance.

**THE CHAIR ONLY:**

**They shall grow not old, as we that are left grow old;  
Age shall not weary them, nor the years condemn.  
At the going down of the sun and in the morning  
We will remember them.**

**THE MEMBERS ONLY:**

**We will remember them.**

**THE CHAIR:**

**Sergeant-at-Arms, deposit the Colours.**  
*(When the Colours have been placed) Colour Party will retire.*  
**Please be seated, I now declare the meeting open.**

**ORDER OF BUSINESS**

**309.** The following is a suggested order of business for Legion meetings.

- a. Indigenous Land Acknowledgment;
- b. Opening ceremony;
- c. Introduction of guests;
- d. Welcoming Ceremony of new members;
- e. Admission of transferred and reinstated members;
- f. Minutes of the last general meeting and intervening meetings;
- g. Business arising from the minutes;
- h. President's report;
- i. Treasurer's report;
- j. Correspondence;
- k. Reports of standing committees;
- l. Reports of special committees;
- m. General business and new business;
- n. General welfare of the Branch and/or Legion;
- o. Special feature (speaker, film, etc.);
- p. Motion of adjournment;
- q. Closing ceremony.

**CLOSING CEREMONY**

**310. Closing Ceremony.** The text that follows is the Ritual for the Closing Ceremony.

**THE CHAIR:**

**The meeting will stand at attention.**

**Sergeant-at-Arms, prepare to march off the Colours.**

**SERGEANT-AT-ARMS:**

**Colour Party, QUICK MARCH.**

*The Sergeant-at-Arms will give the necessary commands to retrieve the colours (see Figure 3-1).*

311. The colour party will advance to the Colours, pick them up to the carry and stand firm.

**THE CHAIR:**

**The business of this meeting being concluded let us, as we part, remember our duty to our Branch, our comrades, our country and our Sovereign. May we ever strive to promote unity and the spirit of comradeship, never forgetting the solemn obligations we have assumed as members of The Royal Canadian Legion and remembering them, may we ever pray.**

**THE MEMBERS:**

**Lord God of Hosts,  
Be with us yet,  
Lest we forget,  
Lest we forget.**

**THE CHAIR:**

**We will now sing "THE ROYAL ANTHEM".**

**Sergeant-at-Arms, march off the Colours.**

312. The Sergeant-at-Arms will give the necessary commands and march off the colour party (see Figure 3-1).

**I now declare this meeting closed.**

**LEGION ORDER OF PRECEDENCE**

313. The order of precedence for the various levels of The Royal Canadian Legion is as follows:

**a. Dominion Appointments:**

- i. The Grand Patron;
- ii. The Honourary Grand President
- iii. The Honourary Vice-President.

**b. Dominion Command:**

- i. The Dominion President;
- ii. The Immediate Past Dominion President;
- iii. The First Vice-President;
- iv. The Vice-Presidents;
- v. The Dominion Treasurer;
- vi. The Dominion Chair;
- vii. Members of the Dominion Executive Council.

**c. Provincial Appointments:**

- i. The Honourary Grand President (as applicable)
- ii. Chaplain (as applicable)

**d. Provincial Command:**

- i. The Provincial President;
- ii. The Immediate Past Provincial President;
- iii. The First Vice-President;
- iv. The Vice-Presidents ;
- v. The Provincial Treasurer;
- vi. The Provincial Chair;
- vii. The Provincial Vice-Chair;
- viii. Members of the Provincial Executive Council;
- ix. District Commanders;
- x. Deputy/Vice District Commanders;
- xi. Members of District Executive Council;
- xii. Zone Commanders;
- xiii. Deputy/Vice Zone Commanders;
- xiv. Members of Zone Executive Council.

**e. Branches:**

- i. The President;
- ii. The Immediate Past President;
- iii. The First-Vice President;
- iv. The Vice-Presidents in order of Seniority;
- v. Other officers in order of Seniority;
- vi. Members of the Branch Executive Committee.

## PARADES

314. When on parade precedence is established by the senior person marching in the right side position of the first file. Others fill from right to left in descending order of precedence.

## BANQUETS

315. Precedence at banquets is established by seating the senior person to the right of the host (President or Chair), the next senior person to the host's left. The procedure is followed for the remaining guests.

## PROTOCOL AT FUNCTIONS

316. **Guests.** The invitation of guests to any function can bring credit and praise upon the Legion and our members. It is also an important way to educate local persons and dignitaries to the good deeds that we as an organization accomplish within our respective communities. However, the manner in which we treat our guests will leave a lasting impression upon them, either good or bad. Therefore, it is in our best interests to invite appropriate guests to appropriate functions and to ensure that they are looked after throughout the function.
317. At any event organized through all levels of The Legion, advanced preparations and final day preparations are always essential for a successful event, the extending of proper protocol to invited guests. They should be made fully aware of your expectations from the time they arrive until the time they depart from the event. This section of the manual should assist you in ensuring that this does happen.
318. **Procedures for Inviting.** In determining a suitable guest for any function it is first necessary to determine how the guest relates to the function being held. Generally the guest should be knowledgeable or associated with the event taking place and will be able to add to the overall success of the event. Additionally, there may be occasions where it would be beneficial to the Legion to invite guests so that they become aware of our activities and can therefore leave the event with a positive perception of our organization and help to spread that perception throughout the community.



- 319.** A potential invitee should be contacted well in advance to ensure that his schedule will permit attendance. Initial contact can be made either in person or in writing. When contact has been made, it will be necessary to provide as many details as possible concerning the event or the nature of the gathering. It should also be indicated to the guest why they have been chosen to come to the function. In essence, be up front and honest as to why you want the guest at your function. Also explain to the guest any sensitivities or peculiarities of the gathering so that they will not be embarrassed during the function.
- 320.** If it is necessary to receive authority for a guest at your function, you will have to follow the procedures laid down by your Command. If the nature of the function or the guest will prove to be controversial, you should also notify your Command as to the arrangements being made. When requesting the attendance of a Dominion Officer at a branch function, the “Request for a Visit by a Dominion Command Officer” form must be completed in triplicate and submitted through the respective provincial command, at least 90 days prior to the event taking place. Copies of this Dominion Command form can be obtained through your provincial command office.
- 321. Funding of Visits for Invited Guests.** If attendance of a Dominion Command officer or member of the Dominion Executive Council has been approved by Dominion Command to attend a function, Dominion Command will assume responsibility for payment of normal expenses as provided for in the travel regulations. However, such approval will be granted only for the most significant of events. Invitations extended by commands and branches to former officers or members no longer on Council should be on a direct personal basis and at the expense of the command or branch concerned.
- 322.** If other guests are invited, the branch or command should bear the costs of the visit and the guests should not have to underwrite their expenses.
- 323. Making the Arrangements.** Now that you have decided to invite a guest to your function, you should also determine if there are any special requirements that the guest needs, such as accommodation,

transportation or any special needs. How we treat our guest while in our company will leave a lasting impression of our organization.

324. First, you should determine if there are any special transportation needs for the guest and if you can help in making those arrangements. Particular attention should be made for any guest with physical disabilities to ensure that they will have access to all venues of the event.
325. Second, you should find out if there are any special accommodation requirements for the guest and again assist in making those arrangements. If necessary you should check and confirm the accommodation reservations to ensure that they are suitable for your guest.
326. You should also determine if your invited guest has any special need's requirements. Again, being prepared for their arrival will negate any last minute arrangements and needless running around. You may also want to assign an escort person to the guest to ensure that any requirement that arises during the visit is looked after in a timely manner. This is particularly useful if the guest is not familiar with the area.
327. Advance copies of programs for the event(s) that your guest will be attending should be mailed to your guest to ensure that the guest is fully aware of their expectations while attending the event(s). If invited guests are arriving from out of town and transportation is not being provided for your guests, they should be made aware of this. In turn, a map should be provided to the guest in advance of their accommodations location and the location of the event(s) taking place.
328. The name of the person your guest should contact upon arrival at the event(s) should be provided along with the time frame. In turn, the contact person should be made fully aware of the arrival time of your guest at the event(s). This will allow the contact person to welcome your guest and review expectations with the guest.
329. **Reception of Guests.** Your invited guests should be met at their point of arrival and either escorted to the event or their accommodation. On arrival, the guests should be provided with an information package

and an itinerary of events. A short briefing on the events will usually suffice to provide the visitors with the needed information. Being met in a friendly and courteous manner will set the visit off on the right foot.

330. Also upon the arrival of your guest, all expectations and involvement in the event(s) should be reviewed. Similarly, if the guest is accompanied by a spouse/partner, the spouse/partner should be given similar respect and all expectations and involvement in the event(s) should be fully explained. Keep in mind that in most cases, the surroundings where the event(s) is being held is foreign to both the guest and spouse/partner.
331. **Introduction of Guests.** It is common practice to ask your guests to provide a short biography which can be used to introduce your guests to the assembled event. You should determine when it is best to provide an informal or formal introduction to your members.
332. In an informal gathering it would be best to introduce the guests to your group by calling their attention to the guests and then provide a short introductory welcome speech. Time should be provided to the guests to respond to the welcome and to say a few words.
333. If a guest has been invited to a more formal occasion such as a dinner, you will need to determine how best to introduce the guest to your membership. One of the best methods is a receiving line at the beginning of the dinner that will provide the guest with an opportunity to meet all members of the gathering. More information on forming a receiving line is provided in Section 337.
334. When you have entered the dining room and after grace has been said and people have sat down, it is normal for the official host to welcome the guest to the gathering. This can be done either after the gathering has sat down or immediately prior to when your guest has been asked to speak. The information gained from the guest's biography should be used here to provide a short and accurate introduction of your guest as well as welcoming him.
335. His Majesty the King or his representative (the Governor General or Lieutenant Governor) is never introduced. They are expected to be known to all. The host should therefore welcome these personages on

behalf of all that are gathered. The welcome should occur before other head table guests are introduced.

- 336. Introduction.** It is normal to invite guests to official functions to enhance the occasion and to pay tribute to those who have supported our organization. Selecting guests for particular functions has to be a careful process to ensure that they are compatible and to avoid unwanted embarrassment. You should inform the guests as to the nature of the function so that they will be comfortable within the setting and what their role will be.
- 337. Types of Functions.** While the list of functions is vast, the more common functions where you may want an official guest are:
- a. Opening of Branches;
  - b. Meetings;
  - c. Parades and Ceremonies;
  - d. Receptions;
  - e. Dinners.
- 338. The Receiving Line.** As mentioned in Section 332, should you decide that a receiving line is a suitable method to introduce your guest to the membership, the following guidelines should apply:
- a. The receiving line should be kept as short as possible;
  - b. The official host should be the first person in the line, followed by the guest of honour, and then followed by the master of ceremonies or the person in charge of the dinner. If spouses are in attendance, they will occupy a position beside their respective partner. Should the official host determine that more persons should be recognized in the receiving line, the host may add more, but numbers should be kept to a minimum to allow for a quick procession;
  - c. When your members go through a receiving line to meet the guest of honour, Legion members will precede their escorts and introduce them to the guest of honour.
- 339. Requirement for the Guest to Give Presentation/Speech.** When inviting a guest to address your audience you should discuss the topic with your guest and provide guidance on those ideas which need to be put forward. You should also highlight any nature of any subject which may be controversial or which needs clarification. In this way your speaker can

best structure his presentation to ensure that it is well received. It is also best to provide the speaker with any background information on the intended audience which will enable the speaker to gain the audience's confidence and attention. You should also discuss with your guest whether or not his comments can be attributed to him or quoted; many guests will not provide candid comments if they are to be attributed. If the guest has no objection, there is no problem. If the guest objects to attribution, you must inform your membership of his wishes. It is not wise to abuse a privileged platform if you want your group to remain credible.

**340. Requirement for a Seating Plan.** In determining how to organize your event, you should decide whether or not a formal seating plan is required for either the head table or all those in attendance. A formal seating plan will allow you to mix the seating arrangement and allow people to make new acquaintances. An informal seating arrangement will allow mutual acquaintances to sit together. In either case, it is usual that a seating plan is set for the head table. In organizing a head table you should determine how large the head table should be. Consideration of the size of meeting hall and the audience need to be taken into account. As you look down from the head table onto the floor, the official host is seated in the middle of the table. The guest of honour should be seated to the right of the host and other guests, in the order of their precedence, should be seated to the left and right alternatively from there. If spouses are in attendance, it is normal that they are seated beside their partner. The master of ceremonies is usually seated to the far right of the host and at the end of the table where they can have access to a microphone if provided.

**341.** At a mixed function with a formal seating plan, it is customary for a gentleman to escort the lady seated to his right into the dinner from the reception area. When escorting, a gentleman offers his left arm to the lady should she need assistance to her place.

**342. Requirement to Present Guest with a Memento.** It is customary that you present your guest with a small memento of the occasion. This memento does not have to be extravagant but should serve your guest as a reminder of his time with you. If your guest has given

a speech, it would be normal to present your memento after you have thanked him for the presentation.

- 343. Toasting.** The offering of a toast is a time-honoured tradition to pay recognition to official guests and to fallen comrades. Toasts are normally offered at the beginning or at the end of the dinner. Toasts can be offered with spirits or wine as well as water. Glasses should not be knocked or “clinked” together when official toasts are offered. In offering a toast, the following sequence should apply.
- “His Majesty the King”, to which assembled members reply “The King”;
  - Other toasts;
  - “To Our Fallen Comrades”.
- 344.** When a toast is offered, all assembled members should rise and reply to the toast. The toast to The King is to precede any other toast.
- 345. The Piper’s Toast.** The use of a piper to lead a head table into position at the beginning of a dinner or to retire the head table at the end of a dinner adds additional ceremony to your event. The piper may also be asked to play a selection during your dinner. However, if a piper is used, the host should be prepared to recognize him by offering a toast in recognition of the piper’s efforts.
- 346.** The piper is asked to step forward to the host’s position. A tray with two drinks is brought forward and offered to the piper and the host. When the drinks are taken from the tray, the piper will raise his glass and give the ancient Gaelic toast:
- Slàinte mhath (*pronounced Slawn-cha Vah’*) meaning “Good health to you”.
- The host, raising his glass, should then reply:
- Slàinte (*pronounced Slawn-cha*) meaning “Good health”.
- 347.** The host and piper drain their glasses and return them to the tray, at which time the piper marches smartly out of the function.
- 348.** If the piper cannot remain at the function to receive his toast after the one to His Majesty the King, then the toast to the piper should not be included in the list of activities.

- 349. Departure of a Guest from a Function.** Unless your guest's schedule has him departing immediately after the function, it is not polite to rush him out. Following a dinner, they should be afforded the opportunity to mix with the group and to get involved in informal social discussions. For your members, it is not normal to leave a function until your guest has departed. If there is occasion where this has to happen then your members should say good evening to the guest and excuse themselves from the function.
- 350.** Additionally, your guest should have enough time to say goodbye to the members in attendance. You should also offer to escort your guest back to his accommodation or if necessary to his point of departure. In either case, you should provide your guest with the necessary transportation.
- 351. Follow up Actions after a Function.** The final aspect for any activity is the actions which are required to thank your guest and to promote the event. As such, you should send a letter of appreciation to your guest and if necessary you should publicize the event in the local media.
- 352. Letters of Appreciation.** A letter of appreciation should be sent to your guest of honour to acknowledge the efforts that they went through to attend and address your function. If necessary and your guest represented an organization, you should also send a letter of appreciation to the governing body of that organization to recognize your guest's contribution. In that way, that organization will feel that they have been recognized and would look favourably on any future requests for guest speakers.
- 353. News Releases.** It is appropriate for any organization to receive public recognition of an event through the local media. This serves to keep the community aware of your organization and how you support local activities. As such, a small article with a photograph would serve your purposes well. If the event was a large gathering, the local media may have covered it already. There is however a word of caution, if your guest speaker was attributed a privileged platform status, this must be emphasized in your news release.

# Welcoming Ceremony

## GENERAL

401. The formal welcoming ceremony is an optional process to membership in The Royal Canadian Legion. If a Branch chooses to retain the welcoming ritual for its membership, the ceremony should be conducted as follows:
402. The Branch President, or an officer delegated by the President, will preside over this ceremony; those members of the Branch Executive Committee taking part in the ceremony are required to be in Legion dress. There is no requirement for the person(s) being welcomed to wear Legion dress.

## WELCOMING

403. Upon review of the membership application and payment of membership dues, the Branch should make the new member aware of the time and date of the welcoming ceremony. This can be done at a regular general meeting or an executive meeting, or if not convenient, at any other time and performed by the Branch President or an officer designated by the President with a witness present.

## THE WELCOMING CEREMONY

### 404. PRESIDING OFFICER:

**Sergeant-at-Arms, please assemble the member(s) for this ceremony.**

*(When the member(s) are in position)*

**Comrade Membership Chair, please present the member(s)**

### MEMBERSHIP CHAIR:

**I am pleased to present to you name(s) and welcome them into the Royal Canadian Legion as a member/as members of Branch name and #.**

### PRESIDING OFFICER:

**Your application(s) for membership into (Branch name and #) of The Royal Canadian Legion has/have been reviewed and approved. The purposes and objects of the Legion are to constitute an association of those who have served or are**



servicing in Her Majesty's armed forces or any auxiliary force and others who support the purposes and objects of the Legion.

The Legion shall stand for Loyalty to the reigning Sovereign and to Canada for strong and united comradeship among all members and those that have served or are serving, so that their rights nor their interests are forgotten, and that their welfare and that of their dependants, especially the dependents of the disabled, the sick, the aged and the needy may always be safeguarded.

The Legion shall encourage, promote, and engage in or support all forms of national, provincial, municipal or community service, or any charitable purpose.

Having heard the purposes and objects of this great organization, are you prepared to subscribe to them and labour to advance the Legion's cause, including active participation in Poppy campaigns?

**NEW MEMBER(S):**

I am.

**PRESIDING OFFICER:**

I now declare you duly admitted to membership in The Royal Canadian Legion, subject to all obligations contained within the organization's By-Laws.

Comrade(s), it gives me great pleasure in extending to you the right hand of comradeship and present you with your Legion badge. It is important that new Legion members become aware of the meaning and significance of our Legion Emblems. The explanation of our Legion Emblems may be found in Section 405 of our Ritual, Awards and Protocol manual.

Comrade Sergeant-at-Arms, please conduct the member(s) to their seat(s).

This completes the welcoming ceremony.

#### **405. EXPLANATION OF LEGION EMBLEMS.**

The following is an explanation of the emblems of The Royal Canadian Legion. It is important that new Legion members be aware of their meaning and significance.

**THE NATIONAL FLAG OF CANADA** – represents our country throughout the world. The red and white are the colours of Canada. The Maple Leaf has been regarded as a Canadian Emblem since 1700. Since its inauguration in 1965, it has flown over Canada during the Gulf War, the Afghanistan War on Terrorism and many United Nations and NATO Missions.

**THE CANADIAN RED ENSIGN** – holds a special place in the hearts and minds of veterans and all Canadians. The 1922 to 1957 version flew over Canada during World War II, the Korean War, the reigns of George V and George VI, and the Coronation of Elizabeth II.

**THE ROYAL UNION FLAG** – more commonly called the Union Jack, is a symbol of Canada's membership in the Commonwealth of Nations and of her allegiance to the Crown and our affiliation with the Royal Commonwealth Ex-Services League (RCEL).

**THE BLOOD RED POPPY OF FLANDERS** – is immortalized as an emblem of sacrifice and Remembrance for the honouring of the thousands who laid down their lives for those ideals which we, as Canadians, cherish. The Poppy calls upon us to remember not only those who have died, but also those they left dependent and those who still suffer from honourable wounds and disabilities. The Poppy challenges us to serve in peace, as in war, to help those who need our help and to protect those who need our protection.

**THE TORCH** – is symbolic of justice, honour and freedom for which our comrades fought and died. We who are left must pledge ourselves to hold it high lest we break faith with those who died.

**OUR BADGE** – is a symbolic badge.

**THE CROWN** – is the St. Edward Crown used by the Sovereign.

**THE RED MAPLE LEAF** – on a white background is derived from the Canadian coat of arms.

**OUR PLEDGE AND MOTTO** – *Memoriam Eorum Retinebimus* (We Will Remember Them) - is in the outside circle. It is in Latin, a language generally used on badges, crests and banners of national and military emblems.

**THE WORD LEGION** – in gold, and the background in blue represents the official colours of the Legion.

**THE POPPY** – is the symbol of Remembrance.

**THIS BADGE** – was approved by the Sovereign. It is to be worn honourably and proudly.

# Installation of Officers and Executive Committee Members

## DRESS

501. All officials participating in an Installation Ceremony are to be in full Legion dress including medal(s), beret and gloves. Chapter 1 of this manual refers.

## ORDER OF CEREMONY

502. When this procedure is used for Command, District and Zone installations, substitute the appropriate word for “Branch” wherever necessary.
503. The President appoints an Installing Officer and a Sergeant-at-Arms for this ceremony. As the Sergeant-at-Arms is the first Branch Officer to be installed, this person may relieve the Acting Sergeant-at-Arms from his duties once the installation has taken place.
504. The Installing Officer instructs the Sergeant-at-Arms to escort each Officer from the rear of the hall or other gathering area to the platform for installation. The Vice-Presidents are escorted as a group together as are the members of the Executive Committee.
505. In addition to a chair for the Installing Officer, sufficient chairs should be placed on the platform to accommodate all persons who are to be installed in office.
506. Following each installation, congratulations should be extended by the Installing Officer.
507. The format for the installation of Branch Officers and Executive Committee members follows and it is presented in the order that these comrades are to be installed.

## **INSTALLING OFFICER**

508. The Installation Ceremony commences when the Installing Officer moves to the podium and states:

### **INSTALLING OFFICER**

**The meeting will come to order.**

## **INSTALLATION OF THE SERGEANT-AT-ARMS**

### **ACTING SERGEANT-AT-ARMS:**

Comrade Installing Officer, I present to you the newly elected/appointed Sergeant-at-Arms Comrade [name] for installation.

### **INSTALLING OFFICER:**

Comrade [name], you have been elected/appointed Sergeant-at-Arms of this [Branch name] Branch [Branch number] of The Royal Canadian Legion. It is your duty to assist the President in maintaining order during meetings; to see that only those duly qualified are permitted to attend the meetings; to be responsible for the Colours and other Branch insignia; and to perform other duties assigned to you by the President.

I now declare you duly installed as Sergeant-at-Arms.

---

**NOTE: At this point in the Installation Ceremony the newly installed Sergeant-at-Arms may assume this role for the remainder of the installations. Regardless of the status of the Sergeant-at-Arms, be the person Acting or not, the comrade is referred to as “the Sergeant-at-Arms” for the remainder of the Installation Ceremonies.**

---

## INSTALLATION OF THE SECRETARY

### **SERGEANT-AT-ARMS:**

Comrade Installing Officer, I present to you the newly elected/appointed Secretary Comrade [name] for installation.

### **INSTALLING OFFICER:**

Comrade [name] you have been elected/appointed to a most important office. It will be your duty to attend all regular and executive meetings of the Branch and to keep a complete and accurate account of all business transacted.

It should be remembered that your books will be the only record available for future reference covering the business of the Branch during the ensuing term. All correspondence received should be brought immediately to the attention of the President or other appropriate officer.

Your comrades trust that you will carry out your duties in such a manner as to warrant the confidence they have placed in you.

I now declare you duly installed as Secretary of Branch number [Branch number].

Sergeant-at-Arms, please conduct the newly installed Secretary to his/her seat of office.

## INSTALLATION OF THE TREASURER

### **SERGEANT-AT-ARMS:**

Comrade Installing Officer, I present to you the newly elected/appointed Treasurer Comrade [name] for installation.

### **INSTALLING OFFICER:**

Comrade [name], you have been elected/appointed to the important office of Treasurer of this Branch. It will be your duty to ensure that an accurate account of all monies received or paid out by the Branch and a record of all other financial transactions is maintained. You will ensure that all funds are deposited in the name of the Branch, and in a bank or institution designated by the Branch and authorized by the General By-laws.

You will also ensure that Branch books are kept up-to-date at all times, and be ready to produce them whenever called upon to do so by an appropriate authority. It will be necessary for you to work in conjunction with any committee whose duties involve the handling of Branch funds.

I now declare you duly installed as Treasurer of Branch number [Branch number].

Sergeant-at-Arms, please conduct the newly installed Treasurer to his/her seat of office.

## INSTALLATION OF THE SECRETARY-TREASURER

### **SERGEANT-AT-ARMS:**

Comrade Installing Officer, I present to you the newly elected/appointed Secretary-Treasurer Comrade [name] for installation.

### **INSTALLING OFFICER:**

Comrade [name] you have been elected/appointed to a combined office of great importance.

As Secretary it will be your duty to attend all regular and executive meetings of the Branch and to keep a complete and accurate account of all business transacted.

It should be remembered that your books will be the only record available for future reference covering the business of the Branch during the ensuing term. All correspondence received should be brought immediately to the attention of the President or other appropriate officer.

As Treasurer, it will be your duty to ensure that an accurate account of all monies received or paid out by the Branch and a record of all other financial transactions is maintained. You will ensure that all funds are deposited in the name of the Branch, in a bank or other lending institution designated by the Branch and authorized by the General By-laws.

You will ensure that Branch books are kept up-to-date at all times and be ready to produce them whenever called upon to do so by an appropriate authority. It will be necessary for you to work in conjunction with any committee whose duties involve the handling of Branch funds.

Your comrades trust that you will carry out your duties in such a manner as to warrant the confidence they have placed in you.

I now declare you duly installed as Secretary-Treasurer of Branch number [Branch number].

Sergeant-at-Arms, please conduct the newly installed Secretary-Treasurer to his/her seat of office.

## INSTALLATION OF THE CHAIR

### **SERGEANT-AT-ARMS:**

Comrade Installing Officer, I present to you the newly elected/appointed Chair Comrade [name] for installation.

### **INSTALLING OFFICER:**

Comrade [name], you have been elected/appointed to the important office of Chair of this Branch. This is a great responsibility. It will be your duty to attend and preside over meetings of the Branch and of the Branch Executive Committee. Your duties will call for a thorough knowledge of the Legion. You will be required to give careful consideration to the merits of all matters under debate and to conduct all meetings in accordance with parliamentary procedure as set out in the Legion's publication *Rules of Procedure for Legion Meetings*.

I now declare you duly installed as Chair of Branch number [Branch number].

Sergeant-at-Arms, please conduct the newly installed Chair to his/her seat of office.



## INSTALLATION OF THE BRANCH SERVICE OFFICER

### **SERGEANT-AT-ARMS:**

Comrade Installing Officer, I present to you the newly elected/appointed Branch Service Officer Comrade [name] for installation.

### **INSTALLING OFFICER:**

Comrade [name], you have been elected/appointed as Service Officer of this Branch for the ensuing term. As you are aware, service is the main reason for our existence as an organization. This is, therefore, a most important office in the Branch, for on your shoulders rests the responsibility of rendering to your comrades and their dependants, efficient help in ensuring that their claims for benefits under the legislation contained in the *New Veterans' Charter* are presented to the proper authority.

It will be your duty to give advice to ex-service personnel and their dependents, to help them collect pertinent evidence and to present prepared claims to the command service bureau officer.

It will be your duty to entrust, secure and to handle all personal information in accordance with the requirements applicable to privacy legislation

I now declare you duly installed as Service Officer of Branch number [Branch number].

Sergeant-at-Arms, please conduct the newly installed Branch Service Officer to his/her seat of office.

## INSTALLATION OF THE CHAPLAIN

### **SERGEANT-AT-ARMS:**

Comrade Installing Officer, I present to you the newly elected/appointed Chaplain Comrade [name] for installation.

### **INSTALLING OFFICER:**

Comrade [name], the Branch has been pleased to elect/appoint you to the position of Chaplain.

You will, I know, bring dignity and respect to your office. You should keep in touch with the President and other officers and should attend meetings of the Branch whenever possible. You should be ready to take your part in dedication, memorial and funeral services. We entrust you with the spiritual well-being of this Branch.

I now declare you duly installed as Chaplain of Branch number [Branch number].

Sergeant-at-Arms, please conduct the newly installed Chaplain to his/her seat of office.

## INSTALLATION OF THE EXECUTIVE COMMITTEE

### **SERGEANT-AT-ARMS:**

Comrade Installing Officer, I present to you the newly elected/appointed Executive Committee Comrades [names] for installation.

### **INSTALLING OFFICER:**

Comrades [names], your election to the Executive Committee is an indication of the high esteem in which you are held by the members of your Branch. You, together with the other elected officers, bear the full responsibility for the conduct of the affairs of this Branch of The Royal Canadian Legion as directed by its general membership.

I now declare you duly installed as the Executive Committee of Branch number [Branch number].

Sergeant-at-Arms, please conduct the newly installed Executive Committee to their seats of office.

## INSTALLATION OF THE VICE-PRESIDENTS

### **SERGEANT-AT-ARMS:**

Comrade Installing Officer, I present to you the newly elected/appointed Vice-Presidents Comrades [names] for installation.

### **INSTALLING OFFICER:**

Comrades [names], you have been elected/appointed by your fellow members to be the First, Second and Third Vice-Presidents respectively of this Branch. In the absence of your president, all rights and powers vested in the President shall, for the time being, be committed to your charge in accordance with your seniority of office.

It will also be your responsibility to carry out any duties assigned to you by the President.

Do you then pledge yourselves to assist your president and to well and truly carry out the duties of your office?

### **VICE-PRESIDENTS:**

I do.

### **INSTALLING OFFICER:**

Then Comrades [names], I have much pleasure in declaring you duly installed as First, Second and Third Vice-Presidents respectively of Branch number [Branch number].

Sergeant-at-Arms, please conduct the newly installed Vice-Presidents to their seats of office.

## INSTALLATION OF THE PAST PRESIDENT

### **SERGEANT-AT-ARMS:**

Comrade Installing Officer, I present to you the Past President, Comrade [name] to be installed.

### **INSTALLING OFFICER:**

Comrade [name], I take this opportunity to express the thanks of your comrades for your contribution to the progress of this Branch through your leadership during your term as President.

You have accumulated experience which will be invaluable to your successor. I therefore charge you with a continuing responsibility toward your Branch and the officers who are now entrusted with its affairs.

Are you prepared to accept this responsibility?

### **PAST PRESIDENT:**

I am.

### **INSTALLING OFFICER:**

Then comrade it gives me great pleasure in declaring you duly installed in your new functions as Past President of Branch (name) of the Royal Canadian Legion.

Sergeant-at-Arms, please conduct the newly installed Past President to his/her seat of office.

## INSTALLATION OF THE PAST DISTRICT/ZONE COMMANDER

### **SERGEANT-AT-ARMS:**

Comrade Installing Officer, I present to you the Past District/Zone Commander, Comrade [name] to be installed.

### **INSTALLING OFFICER:**

Comrade [name], I take this opportunity to express the thanks of your comrades for your contribution to the progress of this District/Zone through your leadership during your term as Commander.

You have accumulated experience which will be invaluable to your successor. Therefore I charge you with a continuing responsibility toward your District/Zone and the officers who are now entrusted with its affairs.

Are you prepared to accept this responsibility?

### **PAST COMMANDER:**

I am.

### **INSTALLING OFFICER:**

Sergeant-at-Arms, please conduct the newly installed Past Commander to his/her seat of office.

## RECOGNITION OF THE HONORARY OFFICERS (OPTIONAL)

### **INSTALLING OFFICER:**

Comrade(s) [name(s)], I take this opportunity to congratulate you on your appointment as an honorary [position] of this Branch. This appointment indicates the high esteem in which you are held by the members of this Branch. I know you will maintain a close interest in the affairs of the Branch, and will assist whenever it is possible to do so.

I bring to your attention that with this appointment you have a special responsibility to uphold the purposes and objects of The Royal Canadian Legion.

My congratulations and thanks to you.

## INSTALLATION OF THE PRESIDENT

**NOTE:** It is often the practice to parade the incoming President for installation with the Branch Colours. If it is determined that this practice will be followed, the Sergeant-at-Arms is to be directed to retrieve the Colours, parade the incoming President to the Installing Officer and then replace the Colours following the installation.

### **INSTALLING OFFICER:**

The meeting will come to attention.

### **SERGEANT-AT-ARMS:**

Comrade Installing Officer, I present to you the newly elected President Comrade [name] for installation.

### **INSTALLING OFFICER:**

Comrade [name], you have been elected by your fellow members to be the chief executive officer of this, the [Branch name] Branch of The Royal Canadian Legion. They have faith in your integrity and in your desire to serve the best interests of all veterans and of this Branch in particular. I would remind you that this honour carries with it certain responsibilities.

It will be your duty to attend and preside at all regular and special meetings in addition to all executive meetings of the Branch. It will be your duty to assume responsibility for the care of the Charter and other Branch property.

It will also be your duty to maintain the traditions of the [Branch name] Branch and of The Royal Canadian Legion in general; to preserve the spirit of fair play and comradeship at all times; to set an example of community service to your fellow comrades; to promote the best interests of this Branch and the general welfare of your comrades of The Royal Canadian Legion; to ensure that your Branch is represented at zone and/or district meetings; to cooperate with your executive committee and the general membership of the Branch, always bearing in mind the purposes and objects of the Legion and the duty of all comrades towards those who need assistance.

*(continued)*

## INSTALLATION OF THE PRESIDENT

Before I officially install you in your office, will you give your fellow members an assurance that at all times you will endeavour to carry out, to the fullest extent in your power, your various responsibilities? Are you ready to give such assurance?

**PRESIDENT:**

I am.

**INSTALLING OFFICER:**

Then repeat after me, I pledge myself to perform the duties of my office as President of this, the [Branch name] Branch of The Royal Canadian Legion, faithfully and to the best of my ability.

**INSTALLING OFFICER:**

By virtue of the authority vested in me, I hereby declare you duly installed as President of the [Branch name] Branch of The Royal Canadian Legion. I congratulate you on the honour that has been conferred upon you and wish you a successful term of office.

Sergeant-at-Arms, please conduct the newly installed President to his/her seat of office.

I hereby declare the officers of the [Branch name] Branch of The Royal Canadian Legion officially installed in their respective offices.

*(The Installing Officer turns to the President and states)*

Comrade President, I take much pleasure in extending to you and to all the officers and members of this Branch my sincere good wishes.

## INSTALLATION OF THE DEPUTY/VICE ZONE COMMANDER

### **SERGEANT-AT-ARMS:**

Comrade Installing Officer, I present to you the newly elected Deputy/Vice Zone Commander Comrade [name] for installation.

### **INSTALLING OFFICER:**

Comrade [name], you have been elected by your fellow members to be the Deputy/Vice Commander of Zone [zone name]. When directed by your Zone Commander, all rights and powers vested in the Zone Commander shall, for the time being, be committed to your charge. It will then be your responsibility to carry out the duties assigned to you. Your comrades rely on you to carry out these duties to the best of your abilities, also to give the fullest support to your Zone Commander at all times. Do you then pledge yourself to assist your Commander and to well and truly carry out the duties of your office?

### **DEPUTY/VICE ZONE COMMANDER:**

I do.

### **INSTALLING OFFICER:**

Then, Comrade [name], I have much pleasure in declaring you duly installed as Deputy/Vice Commander of Zone [zone name] of The Royal Canadian Legion.

Sergeant-at-Arms, please conduct the newly installed Deputy Commander to his/her seat of office.



## INSTALLATION OF THE ZONE COMMANDER

**NOTE:** It is often the practice to parade the incoming Zone Commander for installation with the Zone Colours. If it is determined that this practice will be followed, the Sergeant-at-Arms is to be directed to retrieve the Colours, parade the incoming Zone Commander to the Installing Officer and then replace the Colours following the installation.

### **INSTALLING OFFICER:**

The meeting will come to attention.

### **SERGEANT-AT-ARMS:**

Comrade Installing Officer, I present to you the newly elected Zone Commander Comrade [name] for installation.

### **INSTALLING OFFICER:**

Comrade [name], you have been elected by your fellow members to be the chief executive officer of this Zone of The Royal Canadian Legion. They have faith in your integrity and in your desire to serve the best interests of all members and of this Zone in particular.

I would remind you that this carries with it certain responsibilities.

It will be your duty to attend and preside at all regular and special meetings of the Zone, as well as all executive meetings of the Zone. You are to promote and further the interests of the Zone at all times.

It will be your duty to maintain the traditions of the Zone and The Royal Canadian Legion in general; to preserve the spirit of fair play and comradeship at all times; to preserve a non-partisan attitude on all matters; to set an example of community service to your fellow comrades, to safeguard the best interests of this Zone and the general welfare of your comrades of The Royal Canadian Legion; to cooperate with your Executive Council and the general membership of the Zone, always bearing in mind the Purposes and Objects of the Legion and the duty of all comrades towards the disabled, the widow/ers and dependents.

*(continued)*

## INSTALLATION OF THE ZONE COMMANDER

Before I officially install you in your office, will you give your fellow members an assurance that you will endeavour to carry out, to the fullest extent in your power, your various responsibilities? Are you ready to give such assurance?

**ZONE COMMANDER:**

I am.

**INSTALLING OFFICER:**

Then repeat after me: I pledge myself to perform the duties of my office - as Commander of Zone [zone name] of The Royal Canadian Legion, - faithfully, - fearlessly - and in a non-partisan manner - to the best of my ability.

**INSTALLING OFFICER:**

By virtue of the authority vested in me, I hereby declare you duly installed as Commander of Zone [zone name] of The Royal Canadian Legion. I congratulate you on the honour that has been conferred on you and wish you a successful term of office.

Sergeant-at-Arms, please conduct the newly installed Commander to his/her seat of office.

I hereby declare the officers of Zone [zone name] of The Royal Canadian Legion duly installed in their respective offices.

*(The Installing Officer turns to the Zone Commander and states)*

Comrade Zone Commander, I take much pleasure extending to you and to all the officers and members of this Zone my sincere good wishes.

## INSTALLATION OF THE DEPUTY/VICE DISTRICT COMMANDER

### **SERGEANT-AT-ARMS:**

Comrade Installing Officer, I present to you the newly elected Deputy/Vice District Commander Comrade [name] for installation.

### **INSTALLING OFFICER:**

Comrade [name], you have been elected by your fellow members to be the Deputy/Vice Commander of District [district name]. When directed by your District Commander, all rights and powers vested in the District Commander shall, for the time being, be committed to your charge. It will then be your responsibility to carry out the duties assigned to you. Your comrades rely on you to carry out these duties to the best of your abilities, also to give the fullest support to your District Commander at all times. Do you then pledge yourself to assist your Commander and to well and truly carry out the duties of your office?

### **DEPUTY/VICE DISTRICT COMMANDER:**

I do.

### **INSTALLING OFFICER:**

Then, Comrade [name], I have much pleasure in declaring you duly installed as Deputy/Vice Commander of District [district name] of The Royal Canadian Legion.

Sergeant-at-Arms, please conduct the newly installed Deputy Commander to his/her seat of office.

## INSTALLATION OF THE DISTRICT COMMANDER

**NOTE:** It is often the practice to parade the incoming commander for installation with the District Colours. If it is determined that this practice will be followed, the Sergeant-at-Arms is to be directed to retrieve the Colours, parade the incoming commander to the Installing Officer and then replace the Colours following the installation.

### **INSTALLING OFFICER:**

The meeting will come to attention.

### **SERGEANT-AT-ARMS:**

Comrade Installing Officer, I present to you the newly elected District Commander Comrade [name] for installation.

### **INSTALLING OFFICER:**

Comrade [name], you have been elected by your fellow members to be the chief executive officer of this District of The Royal Canadian Legion. They have faith in your integrity and in your desire to serve the best interests of all members and of this District in particular.

I would remind you that this carries with it certain responsibilities.

It will be your duty to attend and preside at all regular and special meetings of the District, as well as all executive meetings of the District. You are to promote and further the interests of the District at all times.

It will be your duty to maintain the tradition of the District and The Royal Canadian Legion in general; to preserve the spirit of fair play and comradeship at all times; to preserve a non-partisan attitude on all matters; to set an example of community service to your fellow comrades, to safeguard the best interests of this District and the general welfare of your comrades of The Royal Canadian Legion; to cooperate with your Executive Council and the general membership of the District, always bearing in mind the Purposes and Objects of the Legion and the duty of all comrades towards the disabled, the widow/ers and dependents.

*(continued)*

## INSTALLATION OF THE DISTRICT COMMANDER

Before I officially install you in your office, will you give your fellow members an assurance that you will endeavour to carry out, to the fullest extent in your power, your various responsibilities? Are you ready to give such assurance?

### DISTRICT COMMANDER:

I am.

### INSTALLING OFFICER:

Then repeat after me: I pledge myself to perform the duties of my office - as Commander of District [district name] of The Royal Canadian Legion, - faithfully, - fearlessly - and in a non-partisan manner - to the best of my ability.

### INSTALLING OFFICER:

By virtue of the authority vested in me, I hereby declare you duly installed as Commander of District [district name] of The Royal Canadian Legion. I congratulate you on the honour that has been conferred on you and wish you a successful term of office.

Sergeant-at-Arms, please conduct the newly installed Commander to his/her seat of office.

*(The Installing Officer turns to the District Commander and states)*

### INSTALLING OFFICER:

Comrade District Commander, I take much pleasure in extending to you and to all the officers and members of this District my sincere good wishes.

## INSTALLATION OF A BRANCH REPRESENTATIVE

### INSTALLING OFFICER:

Comrade [name], your election/appointment to the position of [position] is an indication of the high esteem in which you are held by your Branch. Your position is an important one and the elected officers look to you to assist them in the conduct of the affairs of this Branch to the satisfaction of the general membership.

## **INSTALLATION OF A PROVINCIAL REPRESENTATIVE TO THE DOMINION EXECUTIVE COUNCIL**

### **INSTALLING OFFICER:**

Comrade(s) [name(s)], you have been elected/appointed by your fellow members to the important office of Provincial Representative to the Dominion Executive Council. The duties of this office require your active participation in the decision-making process of the Dominion Command between Dominion Conventions.

It will be your duty to represent your Provincial Command at meetings of the Dominion Executive Council and to represent Dominion Command at meetings of your Provincial Executive Council.

While you are expected to be zealous in representing your Command and in presenting the viewpoint of your Command to Dominion Command, you will be ever conscious of your responsibility as a full-fledged member of the Dominion Executive Council and will at all times give full consideration to the best interests of the Royal Canadian Legion and ex-service personnel in general and will report to your Provincial Executive Council all decisions of the Dominion Executive Council.

I now declare you duly installed to the office of Provincial Representative to the Dominion Executive Council.

## **INSTALLATION OF A PROVINCIAL CHAIR AND VICE-CHAIR**

### **INSTALLING OFFICER:**

**COMRADES [NAMES] IN ELECTING YOU TO THE IMPORTANT OFFICES OF CHAIR AND VICE-CHAIR RESPECTIVELY OF THIS PROVINCIAL COMMAND, YOUR COMRADES HAVE FULL CONFIDENCE THAT YOU WILL DISCHARGE THE DUTIES OF CHAIR OF THE PROVINCIAL CONVENTION AND MEETINGS OF THE EXECUTIVE COUNCIL IN A COMPETENT MANNER.**

**IT WILL BE YOUR RESPONSIBILITY TO SEE THAT THE BUSINESS BEFORE THE CONVENTION AND THE COUNCIL IS CONDUCTED IN AN ORDERLY MANNER IN ACCORDANCE WITH THE RECOGNIZED PROCEDURE. YOUR COMRADES WILL LOOK TO YOU FOR LEADERSHIP, RECOGNIZING YOUR QUALITIES OF PATIENCE, AND YOUR SENSE OF FAIR PLAY AND COMRADESHIP.**

# Ceremonies and Events

## REMEMBRANCE DAY CEREMONIES

- 601. Half-Masting the Canadian Flag - Remembrance Day.** The Canadian Flag is to be half-masted at Legion buildings as outlined in Section 931.
- 602. The National Remembrance Day Ceremony.** The National Remembrance Day Ceremony is held at 11:00 a.m. on November 11th at the National War Memorial in Ottawa under the auspices of Dominion Command.
- 603.** The Ceremony follows this format.
- |                    |  |
|--------------------|--|
| <b>10:30 am</b>    | Parade of massed bands, Dominion Command Colour Party, Veterans, commissionaires, Canadian Armed Forces, RCMP and cadets march to position.  |
| <b>10:45 am</b>    | All participants in position at National War Memorial.   |
| <b>10:50 am</b>    | Governor General arrives and takes position. On arrival the Governor General takes the Vice-Regal Salute from the parade.  |
| <b>10:57 am</b>    | <i>"O Canada"</i>  |
| <b>10:58:30 am</b> | <i>"Last Post"</i>   |
| <b>11:00 am</b>    | First Gun<br>The Silence - Two Minutes duration<br>Second Gun<br><i>"Lament"</i><br><i>"Rouse"</i><br>The Act of Remembrance<br>A full 21 gun salute carried out at proper intervals<br>Prayers<br>Placing of Official Wreaths<br>Benediction and Blessing<br><i>"Royal Anthem"</i><br>Public Wreath Laying<br>March Past. |



604. Official wreaths are laid by the Vice-Regal Party, which consists of:
- a. The Governor General;
  - b. The Memorial (Silver) Cross Mother;
  - c. The Prime Minister;
  - d. Speaker of the House or Senate;
  - e. The Minister of Veterans Affairs;
  - f. The Chief of Defence Staff;
  - g. The youth representatives;
  - h. The Dominion President;
  - i. The Dean of the Diplomatic Corps.
605. Veterans organizations and members of the Diplomatic Corps follow the Vice-Regal Party. There may be special occasions where circumstances dictate that a personage be added to the Vice-Regal Party.
606. During the wreath laying, the band and/or choir performs suitable music. (e.g. *"Abide with Me"*, *"O Valiant Hearts"*, etc.). The John McCrae poem, "In Flanders Fields" should be read or sung as a prelude or during the wreath laying. The text can be found on the inside front cover.
607. Other organizations and individuals lay wreaths after the official wreath laying.
608. Following the playing of *"The Royal Anthem"*, the parade marches past the saluting base where the salute is taken by the Governor General.
609. **Local Remembrance Day Ceremonies.** Local ceremonies should, where possible, conform to the general format of the National Remembrance Day Ceremony.
610. The Order of Precedence for the placing of wreaths is:
- a. A representative of the Sovereign;
  - b. The Memorial (Silver) Cross Mother or a representative;
  - c. A representative of the Federal Government;
  - d. A representative of the Provincial or Territorial Government;
  - e. A representative of the Municipal Government;
  - f. A representative of the Canadian Armed Forces;
  - g. Representatives of the Royal Canadian Legion;
  - h. Representatives of other organizations and individuals.

---

**Note: All wreaths are to be removed the following day of the Ceremony or during the next week at the latest.**

---

611. The suggested order of march for the parade that will follow the Remembrance Day Ceremony is:
  - a. The Royal Canadian Legion Colour Party;
  - b. Band(s);
  - c. Veterans, including RCMP Veterans, and all other Legion members and Ladies Auxiliary members;
  - d. Members of the Canadian Armed Forces;
  - e. Members of the Royal Canadian Mounted Police;
  - f. Members of civilian police forces and fire departments;
  - g. Members of the Sea, Army and Air Cadets.
612. The organizing committee may invite other groups and organizations to participate in the parade.

### **COLOURS - DIPPING**

613. Colours shall not be dipped at any time except for the Legion Banners, which are to be dipped during the playing of the *"Last Post"* for the purpose of Remembrance.
614. At the commencement of the playing of the *"Last Post"*, the Colour party member carrying the Legion Banner shall step forward and dip the Legion Banner in respect for the Fallen. It shall remain dipped during *"The Silence"* and shall be raised slowly during the sounding of *"Rouse"*. If there are more than one Legion Banner, then ALL Legion Banners will be dipped.
615. Legion officers in charge of parties or groups will salute during the playing of *"O Canada"*, *"Last Post"*, *"Rouse"* and *"The Royal Anthem"*. Members of the Legion, who are not part of a formed group, but in Legion dress, shall also salute.
616. The religious portion of the Remembrance Day Ceremony should be short and non-sectarian.

### **DEDICATION OF A MEMORIAL**

617. The dedication of a memorial, be it newly constructed or refurbished, is a significant event in the life of the Legion and the members. The dedication may be as grandiose as the unveiling of a new cenotaph to as simple as the placing of a memorial plaque.

**618.** Any activity of this nature is of extreme importance to the persons affected by the event that is being remembered and care must be taken to ensure that the activities are carried out in a solemn, dignified and respectful manner.

**619. Order of Ceremony.** The recommended manner in which the ceremony should proceed is as follows:

- a. *"O Canada"*;
- b. A hymn;
- c. A scripture reading;
- d. An address if considered appropriate;
- e. The unveiling of the memorial;
- f. Appropriate faith allocation;
- g. The *"Last Post"*;
- h. 2 Minutes of Silence;
- i. *"The Lament"*. The playing of the Lament is optional.  
If played it is not to commence until the 2 Minutes of Silence has elapsed;
- j. *"Rouse"*;
- k. The Act of Remembrance;
- l. The placing of wreaths;
- m. *"The Royal Anthem"*.

### **DECONSECRATING A CENOTAPH, MONUMENT, OR MEMORIAL**

**620.** The Deconsecrating of any cenotaph, monument, or memorial regardless of its age and condition can be a significant event in the life of the Community and the Legion. The deconsecrating ceremony may be as grand or as simple as the Community wishes.

**621. Order of Ceremony.** The recommended manner in which the ceremony should proceed is as follow:

- a. *"O Canada"*;
- b. Opening comments by ceremony MC;
- c. A hymn;
- d. A scripture reading;
- e. An address if considered appropriate;
- f. Appropriate faith presentation or talk;
- g. The *"Last Post"*;
- h. 2 Minutes of Silence;
- i. *"The Lament"*. The playing of the Lament is optional.  
If played it is not to commence until the 2 Minutes of Silence has elapsed;
- j. The Act of Remembrance;

- k. The Declaration of Deconsecration is read;
- l. If possible and appropriate, and with little fuss the removal of all plaques and similar attachments should happen;
- m. *"The Royal Anthem"*.

### FAITH SERVICE

- 622.** The manner in which a Faith related service is to be organized should be done in full consultation with the representatives of the local area as applicable.
- 623. Other Factors.** Should the Faith service be Remembrance-related, the Last Post, Silence, Rouse and The Act of Remembrance can be inserted at an appropriate place.

### CEREMONY - OPENING A LEGION HALL

- 624.** When a Legion Hall is opened, be it a new building or one that has been renovated, it is a very significant event in the life of the community. In order to ensure that the event receives the recognition and publicity deserved, care must be taken to ensure that the opening is carried out in a dignified manner. Care must also be taken to invite persons within the Community who the Legion has worked with to achieve this special moment, those who the Legion will work with when doing community service and those who the Legion will serve.
- 625. Protocol.** In order to ensure that guests, both senior Legion members and federal, provincial and municipal officials, are accorded the respect that their position dictates, consult Sections 315 to 352.
- 626.** Further information can be obtained by contacting Heritage Canada. The web site is - [www.pch.gc.ca](http://www.pch.gc.ca). Once the site has been located go to the A-Z index, look up "protocol" and click on the word.
- 627.** Each provincial and territorial government has a Protocol Office and the addresses are available in the protocol area of the Heritage Canada web site.
- 628. The Opening.** The suggested order of the ceremony is as follows:

- a. Conduct the Opening Ceremony as described in Chapter 3;
- b. Welcoming remarks from the Branch President;
- c. Guests should be introduced in the following order:
  - i. The Guest of Honour - if the Guest of Honour is one of the persons named below the individual will be introduced here;
  - ii. The Dominion President;
  - iii. The Provincial President;
  - iv. The Member of Parliament for the federal riding in which the Branch is located;
  - v. The Member of the Provincial Legislature for the provincial riding in which the Branch is located;
  - vi. The mayor and/or reeve;
  - vii. The District Commander;
  - viii. The Zone Commander;
  - ix. The Branch President if the president is not performing the responsibilities of the Opening Ceremony Chair;
  - x. The Chair of the Building Committee;
  - xi. The Chair of the Finance Committee.
- d. The Guest Speaker who may, at the conclusion of his/her remarks, be called upon to cut a ribbon that will symbolically open the building while at the same time declaring the building officially open;
- e. The Faith representative should be called upon to conduct the Dedication;
- f. The Branch President thanks the Guest Speaker, The Faith representative, the various Building Committee members, the Ladies Auxiliary for their support, and the persons from private industry responsible for designing and doing the construction or renovations (if applicable);
- g. Announcements such as refreshments, tours, etc.;
- h. Conduct the Closing Ceremony as described in Chapter 3;
- i. Move into the social phase of the occasion.

**629. Other Significant Events.** The format for the ceremony outlined above can be adapted for other events where community leaders and members of the public will be present at a Legion sponsored activity.

## HONOURS AND AWARDS PRESENTATIONS

630. The presentation of an Honour or Award to a Comrade is a significant moment in that person's life. It matters not what the Honour or Award is for, but it matters much how the presentation is handled. The presentation must be done in a dignified and professional manner. After all, the comrade who is receiving the award has earned this recognition and it is the responsibility of the Executive to follow through in an appropriate manner.
631. Honours and Awards presentation ceremonies may be arranged for most any occasion such as regular Branch meetings, functions - for example formal dinners, or gatherings arranged specifically for this purpose.
632. Care must be taken when selecting the person who will bestow the award on the comrade(s) who are to be honoured. The presenter must have the respect of those who will be present at the ceremony and be knowledgeable of the nature of the achievements that will be recognized. Care must be taken to ensure that the presenter is fully briefed on what is expected of him/her and what can be expected to be encountered at the presentation ceremony.
633. It is obvious that senior or other prominent members of The Royal Canadian Legion will be called upon to make presentations; however, prominent members of the community may also be asked to participate. Such an occasion offers members of the Legion to showcase the Branch and demonstrate the level of activity within the community. It also serves to sensitize key members of the community as to how vital the Legion is to community life.
634. When presentations are made the citation should be read in full. It would be a disservice to the recipient(s) to do otherwise.

## GENERAL PURPOSE GRACE AND INVOCATION

635. Any such requirements are to be developed locally in consultation with the appropriate local Faith Representatives to reflect the proper Grace and/or Invocation and words of thanks. The CAF Chaplain Manual can be consulted if necessary at <https://www.canada.ca/en/department-national-defence/services/benefits-military/health-support/chaplain.html>.

# Legion Funerals

## INTRODUCTION

- 701.** This chapter discusses the manner in which funeral services are conducted for members of The Royal Canadian Legion, Veterans and the Ladies Auxiliary.
- 702.** The list that follows outlines the matters that must be considered when there is a requirement to conduct a funeral service.
- a. The definition of a veteran;
  - b. The two types of a Legion funeral service;
  - c. Symbols that are used during the Legion Tribute;
  - d. Action to be taken upon the notification of a death;
  - e. Activity in preparation for and during the Legion Tribute;
  - f. Ceremonial activities;
  - g. The Funeral Service for Veterans and Ordinary Members:
    - i. The Funeral Service;
    - ii. A Grave Side Service;
    - iii. A Memorial Service.
  - h. The Funeral Service for all other Legion members and members of the Ladies Auxiliary;
    - i. The Funeral Service;
    - ii. A Grave Side Service;
    - iii. A Memorial Service.
  - i. Summary.
- 703.** The remainder of this chapter is devoted to outlining the above processes and procedures.

## VETERAN - DEFINED

- 704.** At the 2014 Dominion Command Convention held in Edmonton, Alberta, the Legion updated the definition of a Veteran. This definition can be found in the General By-Laws of the Royal Canadian Legion under Sub Section 101.d.

## TYPES OF LEGION FUNERAL SERVICES

705. Within the Royal Canadian Legion there are two forms of a funeral service for departed comrades. The services are:
- a. A funeral service for a Veteran and other Ordinary members;
  - b. A funeral service for all other members, to include non-veterans, Associates, Affiliate voting and non-voting members and members of the Ladies Auxiliary.

## SYMBOLS

706. The symbols used at the Legion Tribute are:
- a. The Lapel Poppy used at a funeral service for a Veteran or other Ordinary member;
  - b. The Red Maple Leaf used at the funeral of all other members- Associate, Affiliate voting and non-voting members and members of the Ladies Auxiliary.

## NOTIFICATION OF A DEATH

707. Upon the notification of the death of a Legion member or member of the Ladies Auxiliary, the following action should be taken.
- a. Exterior flags are to be lowered to the half mast position and remain in this position until the comrade has been buried or the period of mourning has passed;

---

**Note: This normally should not exceed 7 days.**

---

- b. The family may be contacted to determine what assistance the Branch can provide. Some examples of assistance are - does the family wish a Legion Tribute as this is a decision for the family; does the family wish Legion pall bearers; does the Branch provide a reception after the funeral and if so does the family wish to take advantage of the offer; etc.;
- c. A wreath should be sent to the funeral home;



- d. If a Legion tribute is to take place action must be taken to notify the following persons;
  - i. The Branch President;
  - ii. Applicable Faith Representative;
  - iii. The Sergeant-at-Arms or designate;
  - iv. The members;
  - v. Consideration also has to be given to notifying other Branches of the death and all details of Legion involvement.
- e. For the purposes of this chapter the persons listed above at i. and ii., are referred to as the Comrade in Charge as each may be required to conduct a Legion funeral service;
- f. It is further recommended that the Branch Charter and/or the Ladies Auxiliary Branch Charter be draped until the Comrade has been buried or the period of mourning has passed.
- g. All of the other details that must be pulled together to ensure that the comrade is properly honoured.

### ACTIVITIES - THE LEGION TRIBUTE

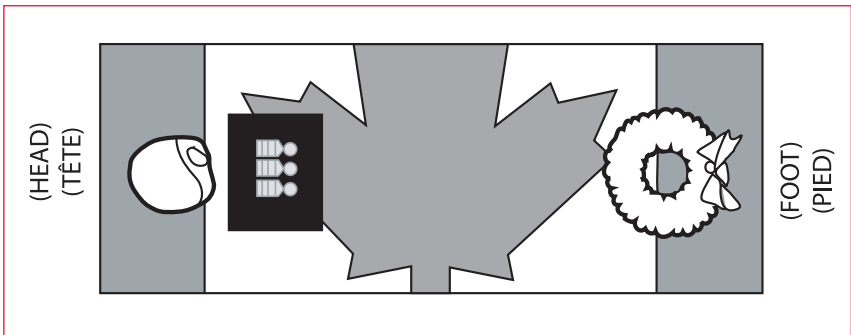
- 708.** The Legion Tribute is the ritual that is used to pay homage, grieve, remember and say goodbye to a departed comrade. When the Tribute is conducted, the degree to which it will be performed will depend on local circumstances. At a minimum, the following should occur:
- a. Veterans or other Ordinary Members - the placing of at least one Poppy, The Silence and The Act of Remembrance should be included in the service;
  - b. Other Members and the Ladies Auxiliary - the placing of at least one Maple Leaf.
- 709.** The requirements that must be taken into consideration are as follows:
- a. **Dress.** It is not normal practice for berets to be worn indoors with the exception of the Sergeant-at-Arms, Colour Bearer(s), and/or Honour Guards, members of the Ladies Auxiliary and by members whose religious doctrine or customs require that the head be covered. Berets may be worn immediately following the service to permit a salute when passing by the remains of the deceased or the memorial display;

- b. Procedure - Legion Tribute.** The place where the Tribute will take place may be a funeral home, a Legion Branch, a place of Faith, a private residence or other place. Regardless of the location, care must be taken to ensure that all involved with the funeral are aware of their responsibilities and that persons not associated with the Legion are aware of what will occur. The points that follow are of particular importance as they are key to a dignified and meaningful tribute;
- i. If *"Last Post"*, *"Rouse"* and/or other music is to be played there is a requirement to advise the Funeral Director and take into account any advice that may be provided. If the Director will play the music they must be made aware of the appropriate time. If a comrade is to play the music, either live or on tape, the Director must be aware;
  - ii. Poppies or Maple Leaves are to be distributed to the comrades as they arrive. It is Legion practice for the Poppy or Maple Leaf to be worn on the Legion blazer prior to being removed to be placed on the casket;
  - iii. Prior to the Tribute, all comrades participating should be gathered together and briefed on the procedure that will be used. The briefing should include the route to be taken, the number of persons per group who will go forward to place their tribute, the direction in which they will leave the casket, and the route to leave the room;
  - iv. At the appointed time, comrades move into the area where the tribute will occur under the direction of the Sergeant-at Arms. Comrades will march in pairs, led by the Branch President and the Comrade in Charge. The group will follow in order of seniority, Dominion Command representatives leading, followed by Provincial Command representatives, followed by District, Zone, Branch Executive representatives and Branch members;
  - v. When all comrades are in position, the Sergeant-at-Arms moves to a position near the head of the casket;

- vi. The cue for the Comrade in Charge to commence the Legion Tribute is the Sergeant-at-Arms taking his position near the head of the casket.
- c. **Placing - Poppies and Maple Leaves.** The information required to conduct this part of the Tribute is as follows:
- i. The Comrade in Charge will place the first Poppy or Maple Leaf and then return to his position;
  - ii. Comrades will then commence to place their Poppies or Maple Leaves. Two comrades will move forward at a time, place the Poppy or Maple Leaf, step back one pace, bow, turn left or right and march to the rear of the group. At this point a new group will start to form;
  - iii. Each pair of comrades will follow the same procedure moving forward as the comrades to their front move away from the casket;
  - iv. As each line completes the tribute the assembly will move forward one pace;
  - v. Once all others have placed their Poppy or Maple Leaf the Sergeant-at Arms will salute and place his Poppy or Maple Leaf and return to his position;
  - vi. The cue for the Comrade in Charge to complete the ceremony is the Sergeant-at-Arms taking his position near the head of the casket;
  - vii. Upon completion of the prayer or benediction the Comrade in Charge, followed by the Branch President and all remaining comrades will pay their respects to the family and move out of the area;
  - viii. The Tribute has been completed.

## CEREMONIAL ACTIVITIES

710. There are selected ceremonial activities that may or may not occur depending on local circumstances. Should these activities occur, the procedures to be followed are as listed below.
- a. **Covering the Casket.** It is the responsibility of the designated Legion member, through the Funeral Director if desired, to determine if the family wishes to drape the casket with the Canadian Flag without a fringe and the departed comrade's beret, medals and a wreath. Figure 7-1 shows the manner in which the items listed above are to be placed. The point of the Maple Leaf in the Canadian Flag is to be adjacent to the deceased's heart;



## Figure 7-1 — Placement of Flag, Beret, Medals and Wreath

- b. **The Canadian Flag.** At the request of Faith Representative, a ceremony to remove and replace the Canadian Flag before and after the church service may be conducted;
- c. **Directions for Folding the Canadian Flag.** Proper method for folding the Canadian Flag will follow the Government of Canada directions available at: <https://www.canada.ca/en/canadian-heritage/services/flag-canada-etiquette/folding.html>.
- d. **Presentation of the Canadian Flag.** The Canadian Flag. The deceased member's Branch may wish to present the Canadian flag to the next-of-kin. The flag folding ceremony is to occur immediately prior to the casket being interred;
- e. **Presentation of the Beret and Medals.** If the Legion Tribute occurs during the evening prior to the funeral service, the Funeral Director is to remove, care for and return the beret and medals to the next-of-kin following burial. Should the Legion Tribute occur at the funeral or at the grave site, the Funeral Director will remove and pass the beret and medals to a designated Legion member. The Comrade will be responsible to present these items to the next-of-kin at an appropriate time;
- f. **Pallbearers.** Pallbearers, when carrying the casket, may remove their headdress. If the headdress is removed it is to be replaced at the grave side immediately before The "Last Post" is sounded;

- g. Leaving the Service.** If it is intended that the Legion members precede the casket and bearers out of the location of the service they will line up on both sides of the exit and form a Guard of Honour and will remain until the cortege has left. If the Guard of Honour is to proceed to the cemetery, it will hold its position until the casket is placed in the hearse and then move to the transportation being provided.

# FUNERALS FOR VETERANS AND ORDINARY MEMBERS

## THE FUNERAL SERVICE

711. The form that the funeral service will take may have been predetermined by the departed comrade and/or the family. In addition, the Faith representative who will conduct the service has the responsibility to see that the deceased's and family's wishes are respected.
712. The Legion is present to support the family and to honour the departed comrade. To this end, it is imperative that the Faith representative understand the symbolism of the Legion Tribute and the Legion members participating must be aware of the requirements of the Faith representative. The only way that both parties can be informed of each other's needs is through communication. To ensure effective communication the Legion should take the initiative and contact the Faith representative to discuss the arrangements for the funeral.
713. **The Legion Order of Service.** The Legion Order of Service or Legion Tribute as it is often called is a funeral service that has been developed to permit members to say goodbye to their fallen comrade. The Poppy is an integral part of the service, and its use must be planned so as not to detract from the dignity of the occasion. Consideration must be given to the wishes of the family, the officiating Faith representative, local customs and location. The service is conducted in the following manner.
- a. **The Faith representative or Comrade In Charge** request the gathering to stand:
  - b. **The Faith representative or Comrade In Charge:**

**In the presence of the last earthly remains of our Comrade [name], whose loss we mourn but whose spirit still lives, may we, as citizens and members of The Royal Canadian Legion, be charged anew with the full sense of our duties and responsibilities to our country and our organization. May we ever strive to uphold the principles of unselfish service which led us to serve our God and our country in time of war and in peace, so that we may continue to serve, even unto death.**

- c. **The Faith representative or Comrade in Charge** places a single poppy on the casket;
- d. A prayer to the Faith is optional.

**Response:**

**Lest we forget; Lest we forget.**

- e. *“Last Post”* (optional);
- f. The Silence;
- g. *“Rouse”* (optional);
- h. The Act of Remembrance;
- i. **The Faith representative or Comrade in Charge** read and appropriate closing prayer as per the Faith represented.

**Our Heavenly Father, grant, we beseech you, to the loved ones of our departed comrade, your comfort and protection. Amen;**

- j. Poppies may be placed on the casket by a special honour guard and/or all comrades present;
- k. The manner in which the Tribute is to be conducted is shown at Section 708.

### **A LEGION GRAVE SIDE SERVICE**

714. There may be circumstances which preclude a Tribute being conducted at a Funeral Service, but the need for a grave side service has been identified. Regardless of the circumstances a Tribute may occur and the degree to which it will be performed is to be determined locally.

The following order of service is suggested.

- a. Arrangements are to be made in advance with the person who will officiate at the service, the Faith representative or Funeral Director, to position the Legion members for the service and determine when the Tribute will occur;
- b. Prior to commencing the service, Poppies are to be distributed to those who will participate in the Tribute;
- c. **The Comrade in Charge** is responsible for carrying out the Legion Tribute;
- d. Poppies will be dropped into the grave at the conclusion of the Tribute;
- e. Legionnaires in uniform and wearing their headdress will salute after dropping their Poppy;
- f. Other persons will pause a moment, turn and file past the grave.



## A LEGION MEMORIAL SERVICE

715. A Memorial Service is held when there are no earthly remains and the procedure is as follows:

- a. **The Faith representative or Comrade In Charge** should announce the hymn and request the gathering to stand;
- b. The hymn is one that is chosen by the family or Faith representative;
- c. **The Faith representative or Comrade In Charge:**

**We assemble today to solemnly remember and to pay our respects to the life of our comrade [name], whose death we mourn, but whose spirit still lives. May we, as citizens and members of The Royal Canadian Legion, be charged anew with the full sense of our duties and responsibilities to our country and our organization. May we ever strive to uphold the principles of unselfish service which led us to serve our God and our country in time of war and in peace, so that we may continue to serve, even unto death;**

- d. A Prayer (optional);
- e. The Eulogy;
- f. *"Last Post"* (optional);
- g. The Silence;
- h. *"Rouse"* (optional);
- i. The Act of Remembrance;
- j. **The Faith representative or Comrade In Charge** read and appropriate closing prayer as per the Faith represented.
- k. A Memorial Cross, constructed from a porous material, may be placed in position where members may place a Poppy;
- l. The tribute may be carried out at the conclusion of the service.

# **FUNERALS FOR ASSOCIATE AND AFFILIATE LEGION MEMBERS AND MEMBERS OF THE LADIES AUXILIARY**

## **PREFACE**

**716.** The procedures and protocol outlined in this chapter have been developed to provide all members with the knowledge and guidance necessary to ensure that funeral services held for our comrades are conducted in the most dignified manner possible. It is realized that there will be requirements to deviate from these procedures on occasion due to local situations that will develop. All that can be asked in such circumstances is for the comrades who are responsible for funeral services to conduct the services in a manner that demonstrates that the Legion cares.

## **THE FUNERAL SERVICE**

- 717.** The form that the funeral service will take may have been predetermined by the departed comrade and/or the family. In addition, the member of the representative Faith who will conduct the service has the responsibility to see that the deceased's and family's wishes are respected.
- 718.** The Legion is present to support the family and to honour the departed comrade. To this end, it is imperative that the Faith representative understand the symbolism of the Legion Tribute and the Legion members participating must be aware of the requirements of the Faith representative. The only way that both parties can be informed of each others needs is through communication. To ensure effective communication the Legion should take the initiative and contact the Faith representative to discuss the arrangements for the funeral.

**719. Order of Service.** The Order of Service for an Associate or Affiliate member and non-veteran member of the Ladies Auxiliary is as follows:

- a. **Maple Leaves** are to be distributed to those who will participate in the Legion Tribute prior to the commencement of the service;
- b. **The Faith representative of Comrade in charge.** A prayer to the Faith is optional.
- e. **The Faith representative or Comrade in Charge** places a single Maple Leaf on the casket;
- f. An appropriate prayer to the Faith is optional at this time;
- g. The Silence;
- h. Act of Remembrance;
- i. The members go forward and place the Maple Leaves;

**720.** The procedure is as described at Subsection 709.b. (omitting all reference to "*Last Post*" and "*Rouse*").

### **A GRAVESIDE SERVICE**

**721.** The following is the suggested order of service if held at the grave side:

- a. Arrangements are to be made in advance with the person who will officiate at the service, the Faith representative or Funeral Director, to position the Legion members for the service and determine when the Legion Tribute will occur;
- b. Should a Legion Tribute occur, Maple Leaves are to be distributed to those who will participate prior to the commencement of the service;
- c. The Maple Leaves will be dropped into the grave;
- d. **The Comrade in Charge** is responsible for carrying out the Legion Tribute;
- e. Legionnaires in uniform and wearing their headdress will salute after dropping their Maple Leaf;
- f. All other persons will pause a moment, turn and file past the grave site.

## **A MEMORIAL SERVICE**

- 722.** A Memorial Service is held when there are no earthly remains and the procedure is the same as per Section 719. A Memorial Cross or alike to represent the Faith constructed from a porous material, may be placed in position where members may place the Maple Leaf.

# Cenotaphs

- 801.** There are more than 6,000 local cenotaphs/monuments/memorial walls that are dedicated to Canada's war dead and Veterans across Canada. The vast majority of these memorials have been erected in dedicated municipal parks as a result of efforts by local Legion Branches, community groups, Provinces, private sponsors, Regimental associations and other Veterans' organizations.
- 802.** The Government of Canada is committed to preserving the memory of our nation's war dead and Veterans through proper care and conservation of Canada's cenotaphs/monuments/memorial walls. To assist in ensuring this is accomplished, Veterans Affairs Canada in partnership with community groups and local organizations including the Royal Canadian Legion wants to ensure that these memorials are conserved to the highest standard of care and dignity.
- 803.** To this end, VAC has a Cenotaph/Monument Restoration Program in place to monetarily assist Legion branches and other community groups in being able to accomplish this. Through this program, communities and Legion branches across Canada will be able to restore Cenotaphs and Monuments that promote and preserve the memory of all those who have served Canada since 1867. Guidelines have been established to review requests and evaluate Cenotaph/Monument restoration projects in a fair and equitable manner. The program guidelines can be viewed on the Veterans Affairs website at **[www.veterans.gc.ca](http://www.veterans.gc.ca)**.

- 804.** From time to time, Legion Branches are instrumental in community Cenotaph/Monument restoration projects. When considering such projects, full consideration should be given to the fact that cenotaphs, monuments and memorial walls serve a specific purpose within communities. The specific purpose is that such memorials are dedicated to Canada's war dead and Veterans, and full respect and dignity should be given to them. Any restoration or modification project of Cenotaphs must be fully reviewed and approved by Veterans Affairs Canada before any work is undertaken as per Section 803.
- 805.** The area in which they are located within communities are considered sacred grounds and should receive the respect and dignity they so rightly deserve. With the purpose of the Cenotaphs, Monuments or Memorial Walls being to preserve the memory of our war dead and Veterans, any names inscribed within the given area of such memorials should only be those of our Veterans and war dead, not the general public. Should the local Legion Branch and/or community wish to include names of various donors etc., for such cenotaph projects, these names should then be included in an area separate from the area where the cenotaph/monument dedicated to the war dead is located.

# Flags, Colour Parties and Parades

## FLAGS AND BANNERS

- 901. Use, Precedence and Formations.** The flags approved for use by The Royal Canadian Legion and their Order of Precedence is listed below.
- a. The Canadian Flag;
  - b. The Red Ensign (1922 - 1957);
  - c. The Royal Union Flag colloquially referred to as the Union Jack;
  - d. Provincial and/or a Territorial flag;
  - e. The United Nations Flag;
  - f. NATO Flag;
  - g. The Legion Banner.
- 902.** The flags shall be displayed or carried on the following occasions.
- a. At Legion parades and meetings;
  - b. On significant national, provincial/territorial and civic occasions.
- 903.** The Canadian Flag may be displayed on an appropriate pole outside of a Legion building. Flag protocol state that it would always be flown on its own mast or flag pole and that it is improper to fly two or more flags on the same pole (e.g. one beneath the other), with the exception of section 905.
- 904.** Legion Colours may be displayed outside of a Legion building providing flag poles are available. For example, a Legion building with two flag poles would fly the Canadian and applicable Provincial or Territorial Flag.
- 905.** The Poppy banner may be flown at all Legion Branches during the annual November Remembrance period. It is to be flown on the flagpole below the Canadian flag.
- 906.** A provincial or territorial flag may be carried with the Dominion Colours as the circumstances warrant for a local event (see section 938).

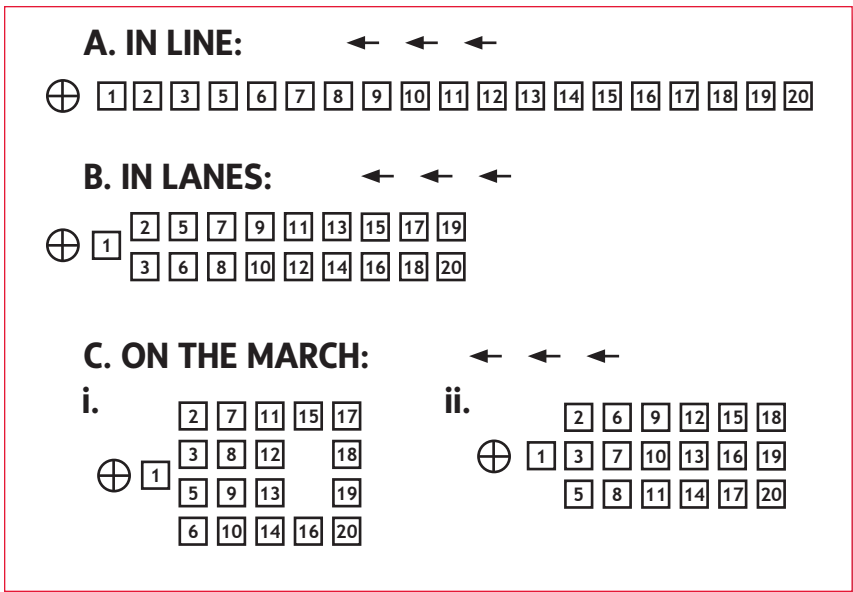
907. At national events, the 13 Provincial and Territorial flags should be carried and/or displayed separately from the Dominion Command Colours.
908. **Precedence - Provincial and Territorial Flags.** When more than one provincial or territorial flag is flown, the order of precedence is:
- a. Ontario;
  - b. Quebec;
  - c. Nova Scotia;
  - d. New Brunswick;
  - e. Manitoba;
  - f. British Columbia;
  - g. Prince Edward Island;
  - h. Saskatchewan;
  - i. Alberta;
  - j. Newfoundland & Labrador;
  - k. Northwest Territories;
  - l. Yukon;
  - m. Nunavut.
909. When all provincial and territorial flags are paraded or placed in single file with other approved flags, they shall appear as in Figure 9-1 A.
910. When all provincial and territorial flags are paraded in two files with other approved flags, they shall appear as in Figure 9-1 B.
911. When all provincial and territorial flags are paraded in a marching formation with other approved flags, they shall appear as in Figure 9-1 C.
912. **United States of America.** Legion Branches and posts in the United States of America fly the American National Flag as it takes precedence and Canadian Provincial and Territorial flags are not used.

---

**NOTE: The legend in Figure TC-1 in the Table of Contents is to be used when referring to the figures shown in the manual.**

---

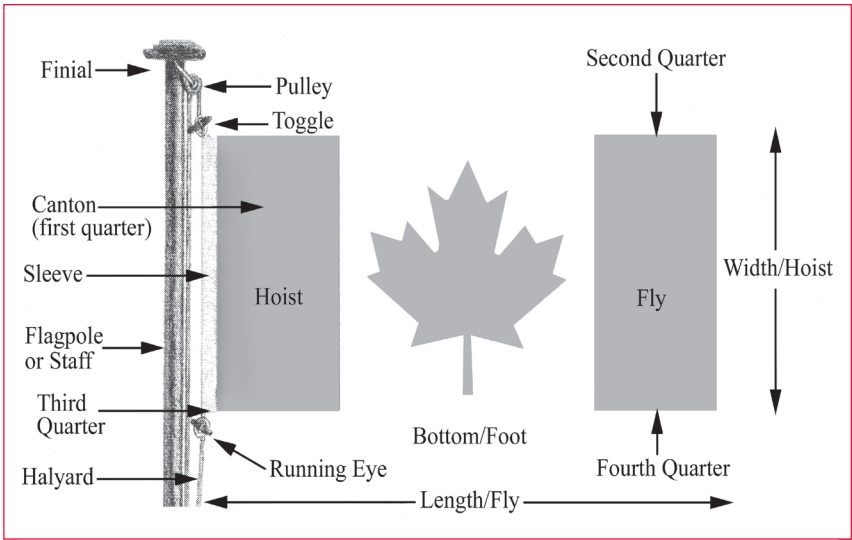




**Figure 9-1 — Flag Formations**

**GENERAL FLAG ETIQUETTE**

913. Questions of flag etiquette not addressed in this manual should be referred to Heritage Canada. The Internet address is - [www.canada.ca](http://www.canada.ca).
914. For the purpose of these instructions the term “flag” will also serve to signify jacks, banners, pennants, ensigns, standards, etc. Also, the term “pike” is intended to signify a relatively short pole which could be carried by an individual for ceremonial occasions and is not permanently mounted. Conversely, the term “flagpole” (or “mast”) is intended to signify a pole of such dimensions or permanent mounting that precludes it being carried on ceremonial occasions. Flagpoles may be fitted with halyard and pulley systems to enable the raising and lowering of flags flown on them.



**Figure 9-2 — Flag Terminology**

915. It is appropriate for the Canadian Flag to be displayed by individuals and organizations. The manner in which flags may be displayed in Canada is not governed by any legislation but by established practice adapted from international usage and customs of the federal government. At all times the Canadian Flag, as well as other flags, should be treated with dignity and displayed properly, out of respect for what and who they represent. Flags should never be allowed to touch the ground, floor or deck.
916. Flags may be displayed flat or flown at the top of a pike or flagpole and are usually displayed so that the canton (First Quarter) is seen at the upper left when the flag is viewed by spectators from the front.
917. The Canadian Flag may be displayed horizontally or vertically on a wall. When displayed horizontally, the sleeve shall be to the left. When displayed vertically, the top of the leaf is to the left and the stem is to the right.

918. When flags are flown, pikes should be 7 to 8 ft (2.1 to 2.4 m) in length and flagpole lengths should be as follows:

FLAG SIZE	FLAGPOLE LENGTH
3.0 x 6.0 ft (0.9 x 1.8 m)	17 to 20 ft (5.1 to 6.0 m)
4.5 x 9.0 ft (1.4 x 2.8 m)	30 to 35 ft (9.0 to 10.5 m)
6.0 x 12.0 ft (1.8 x 3.6 m)	40 to 45 ft (12.0 to 13.5 m)
7.5 x 15.0 ft (2.3 x 4.6 m)	50 ft (15.0 m)

919. The Canadian Flag may be displayed flat or flown in a church, auditorium, or any other meeting place. When used on a speaker's platform, the Flag should be flown to the right of the speaker. If displayed flat against the wall at the back of the platform, the Flag should be above and behind the speaker. The Flag shall not be used to cover a table or seat or be draped in front of a platform, dais, barrier, etc. When draping, festoons, etc., are required, bunting should be used; not the Flag itself. When used in the body of a meeting place, the Flag should be flown to the left of the audience, as seen by the audience.
920. The Canadian Flag shall be given the place of honour when flown with other flags except for the personal standards of members of the Royal Family or of Her Majesty's representatives in Canada. The manner in which the Canadian Flag is flown is as follows:
- Flags flown together should be approximately the same size and flown from separate mast or flagpole at the same height. International usage forbids the displaying of the flag of one nation above that of another on the same flagpole;
  - No flag shall be flown or displayed above the Canadian Flag. The exception is where a flagpole has a gaff or yardarm;
  - When **two or more than three flags** are flown together, the Canadian Flag shall be on the left, as seen by spectators in front of the flags, with the other flags flown in order of precedence from left to right or alphabetical order for other national flags. The Canadian Flag may be flown at each end of the line;
  - When **three flags** are flown or displayed together, the Canadian Flag shall occupy the central position

- with the next ranking flag to the left and the third ranking flag to the right, as seen by spectators in front of the flags;
- e. Where more than one flag is flown on a group of flagpoles and it is impossible to raise or lower them simultaneously, the Canadian Flag(s) shall be raised first and lowered last;
  - f. When the Canadian Flag is flown alone on one of a group of flagpoles, it shall be flown on the left of two flagpoles or on the flagpole nearest to the centre when there are more than two flagpoles as viewed from the front by spectators;
  - g. When the Canadian Flag is flown crossed with another national flag, it should be on the left with its pike crossed in front of the other, as viewed from the front by spectators.
921. When it is practical, the Canadian Flag is flown daily from sunrise to sunset, however, it is not contrary to etiquette to have the Flag flying at night.
922. The use of the Canadian Flag to cover a statue, monument or plaque for an unveiling ceremony is against Flag Protocol and this practice should be strongly discouraged.
923. The Canadian Flag, the Red Ensign, the Royal Union Flag, a Provincial or Territorial Flag, the UN Flag, the NATO Flag, or the Legion Banner shall not be used as a marker on a Legion parade.
924. Care must be taken when displaying the Royal Union Flag from a pike or flagpole so that the wide white stripe is next to the pike/flagpole and is uppermost.
925. When the Canadian Flag is raised or lowered or when it is carried past in a parade, all present should face the Flag and remain silent. Comrades in uniform shall salute and men in civilian dress shall remove their hats.
926. When a flag becomes noticeably worn, faded or otherwise unfit for service, to prevent its desecration, it should be disposed of privately by burning.

### **HALF-MASTING**

927. A flag flown at half-mast is the universal symbol of mourning, and only flags secured to flagpoles with halyards and pulleys will be half-masted. To place a

flag at half-mast, it shall be raised to the masthead, and then slowly lowered until the flag's centre is midway between the masthead and the base of the flagpole. When lowering a flag from the half-mast, it will first be raised to the masthead, and then lowered in the usual manner.

- 928.** On occasions requiring one flag to be flown at half-mast, all other flags flown with it should also be at half-mast.
- 929.** The Canadian Flag should be flown at half-mast on the following occasions at Legion establishments on flagpole that are fitted with halyards and pulleys.
- a.** Throughout Canada on the death of the Sovereign or a member of the Royal Family related in the first degree to the Sovereign, the Governor General, the Prime Minister, a former Governor General, a former Prime Minister, a federal Cabinet Minister, the Dominion President, a past Dominion president, a Dominion officer and on other occasions as specifically directed by Dominion Command including days declared as days of national mourning;
  - b.** Within a province/territory on the death of the Lieutenant-Governor, the Premier, a Cabinet Minister, the Provincial President, a Past Provincial President, a Provincial Officer and on other occasions as specifically directed by Provincial Command including days declared as days of Provincial/Territorial mourning;
  - c.** Within a riding on the death of the member of the House of Commons or the member of the Provincial/territorial Legislature;
  - d.** Within a district on the death of the District Commander or a former District Commander;
  - e.** Within a zone on the death of the Zone Commander or former Zone Commander;
  - f.** At a Branch on the death of a member or an employee of the Branch or Ladies Auxiliary, and at the discretion of the Branch on the death of a veteran or member of the Canadian Armed Forces;
  - g.** The flag shall be flown at half-mast from the day of death to the day of the funeral or memorial service, except on the death of the Sovereign, when it is raised to full-mast for the day on which the accession of the new Monarch is proclaimed.

**930. Remembrance Day.** It is now Canadian Government policy that all external Canadian Flags are to be flown at half-mast on Remembrance Day “to honour the memory of all Canadians who have served their country in times of war”. The policy is as follows:

- a. The Canadian Flag will be flown at half-mast on all federal government buildings and establishments across Canada from sunrise to sunset on Remembrance Day;
- b. Should half-masting occur near a cenotaph or at another site where Remembrance services are being observed, half-masting can occur from 11:00 a.m. (or according to the prescribed order of service) and extend until sunset on November 11;
- c. The flag on the Peace Tower will fly at half-mast from the commencement of the Remembrance Day service at the National War Memorial in Ottawa, Ontario, and remain in that position until sunset.

**931. Legion Policy.** In order to conform to this Government policy the Legion policy for half-masting the Canadian Flag on Remembrance Day is as follows:

- a. Canadian Flags flown outside Legion establishments where Remembrance Day services will not occur will be flown at half-mast for the day;
- b. External Canadian Flags flown at Branches or cenotaphs where a Remembrance Service will occur will be flown at full-mast until the playing of the first note of the *Last Post*, and then lowered as per custom. The flags will be raised to the full-mast position on the first note of *Rouse* and remain so during the playing of the *Royal Anthem* and march past if applicable;
- c. Canadian Flags referred to above are to be lowered to half-mast following the Remembrance Day Service for the remainder of the day;

**932. Vimy Ridge Day.** The federal government enacted legislation in 2003 declaring April 9th Vimy Ridge Day, a “National Day of Remembrance” to commemorate this famous battle where Canadians did what others could not; capture Vimy Ridge. The Canadian Flag, on the Peace Tower, will be flown at half mast on 9 April from sunrise to sunset. Legion Branches are to fly their Canadian Flags at half mast on 9 April from sunrise to sunset.

## MEMORIAL AND FUNERAL SERVICES

933. Unless there has been a specific request for another flag, a casket will be draped with the Canadian Flag. The Flag should be 4½ ft x 9 ft (1.4 m x 2.8 m) in size. The canton should be draped over the upper left corner of the casket and the Flag should be removed before the casket is lowered into the grave or after the service at a crematorium.
934. When Legion Banners are draped on occasions of memorial or funeral services, black crepe or mourning ribbon 54 inches long and 6 inches wide (135 cm x 15 cm) is used, tied in a bow, just below the spike of the pike.

## THE COLOUR PARTY

935. The flags used by The Royal Canadian Legion are referred to as Colours and our Colours are as follows:
- a. The Canadian Flag;
  - b. The Red Ensign (1922 - 1957);
  - c. The Royal Union Flag;
  - d. The appropriate Provincial or Territorial flag(s);
  - e. The United Nations Flag;
  - f. The NATO Flag;
  - g. The Legion Banner.
936. In addition there may be enhanced Colour Parties that, in addition to the flags referred to above, carry all other Provincial and Territorial flags.
937. The Dominion Command Colour Party carries 19 flags - the six colours and the 13 Provincial and Territorial flags.

---

**Note - While the composition of the Legion Colour Party remains unchanged, Legion activities may include other flags and banners in a parade that would follow the Legion Colour Party. The placement of such other flags and banners is at the discretion of the Legion organizers so long as they follow the Legion Colour Party.**

---

938. The Colour Party may be commanded by one of the following persons.
- a. A Sergeant-at-Arms;
  - b. A Colour Party Commander; or,
  - c. The Comrade carrying the Canadian Flag.

939. The term Colour Party is to be interpreted to mean any of the appointments noted above and the group of persons carrying the flags.
940. **Dress and Deportment.** Members of the Colour Party, including the Colour Party Commander and Parade Commander, shall wear Legion dress as shown in Chapter 1 of this manual. A Lapel Poppy shall be worn on the Legion blazer; gloves or gauntlets and slings, are to be worn when handling the Colours.
941. Comrades selected to be part of the Colour Party must receive training that addresses basic drill movements, flag protocol and flag drill. The information addressing these drill movements may be found in Chapters 9 and 10 of this manual.
942. **Parading the Colours.** The Colours are paraded on the following occasions.
- a. At the Opening and Closing Ceremonies of Legion meetings;
  - b. On Legion parades such as a Church Parade, Decoration Day, Memorial Day, Remembrance Day and related ceremonial occasions;
  - c. Colours may also be paraded at community, provincial/territorial or national events that are considered important;
  - d. At the discretion of a Branch President, Zone or District Commander, Provincial or Dominion Command President when it is believed that the image of the Legion will be enhanced by the presence of a Colour Party.
943. **Parades.** When the Colours are on parade they may be carried as described below.
- a. When a parade is standing at attention, the Colours may be at the ORDER or the CARRY;
  - b. When an inspection is taking place the Colours shall be at the CARRY;
  - c. When on the march the Colours shall be at the Carry;
  - d. On occasions when the command "EYES RIGHT/LEFT" is given to a marching contingent, the command does not apply to members of a colour party who are carrying colours. Colour bearers are to face forward at all times.



- 944. Salutes.** On occasions when a General Salute is played the Colours are let fly.
- 945. Dipping of the Legion Banner.** It is Legion policy, as directed by Dominion Convention and Dominion Executive Council, to dip the Legion Banner during the playing of the *"Last Post"* for the purpose of Remembrance. If more than one Legion Banner is being carried, then ALL are to be dipped.
- When the first note of the "Last Post" is sounded, the Legion Banner is dipped in a slow and dignified manner, held in the dipped position during the Silence, and recovered in a slow and dignified manner when the first note of "Rouse" is sounded. The Legion Banner should achieve the Carry position on the last note of *"Rouse."* (Also see Section 614)
- 946.** The Legion Banner should not be allowed to touch the ground.

## PARADES

- 947. Parade Formation.** When The Royal Canadian Legion is on parade the members parading form up in three ranks. The number of members present will determine the number of contingents required to exercise adequate control over the parade. As a guide it is recommended that no more than 50 members march as a contingent. Each contingent will be under the control and direction of a Commander.
- 948. Marching On The Colours.** Prior to receiving the order to march the Colours on parade, the Colour Party will have formed up in an area adjacent to the designated parade forming up point. At the designated moment the Parade Commander will give the order "MARCH ON THE COLOURS".
- 949.** The Colour Party marches to a predetermined location within the parade and the Colours will be at the Carry. If a band is present appropriate music is to be played. The official march of The Royal Canadian Legion is *"UNITY"* (see page 163).
- 950.** Once the Colour Party reaches the designated location and is properly positioned it shall act on the Parade Commander's commands.

951. As stated the Colour Party is under the command of the Parade Commander; however there are four occasions when the Colour Party must take independent action which are:
- a. During an inspection the Colour Party Commander shall order the Colours held at the CARRY;
  - b. Prior to stepping off on the march the Colour Party Commander shall order the Colours held at the CARRY;
  - c. When required to move to a flank independently, the Colour Party shall do so on the Colour Party Commander's word of command;
  - d. Changing the hand that is holding a flag on the march.
952. **Marching Off The Colours.** At the conclusion of a parade, the Parade Commander gives the order "MARCH OFF THE COLOURS".

The Colour Party Commander gives the appropriate order(s) - ie. CARRY COLOURS, if required directs a RIGHT OR LEFT TURN, QUICK MARCH to move the Colour Party to a designated area adjacent to the parade for dismissal. If a band is present appropriate music is to be played.

## LARGE ASSEMBLIES

953. **General.** A procedure exists for an enhanced Colour Party (one that carries all Legion related flags) to parade the Colours to the area set aside for the head table and deposit and retrieve the Colours at the appropriate times. The reference for the manner in which flags have been numbered is shown at Figure TC-1 and the procedure is shown in the diagram at Figure 9-3. There is a requirement for the Colour Party to rehearse the procedure and the rehearsal should occur after the hall has been prepared for the assembly.
954. **Marching On The Colours.** The Sergeant-at-Arms forms up the Colour Party at the rear of the hall being used for the assembly.
- a. Once the assembly has been called to order, the Chair will give the command "MARCH ON THE COLOURS". The Sergeant-at-Arms, in a clear and strong voice, orders "CARRY COLOURS ..... QUICK MARCH". If a band is present appropriate music is to be played. The bandmaster's cue to commence

playing is the word of command "MARCH"; therefore a clear and strong voice is necessary;

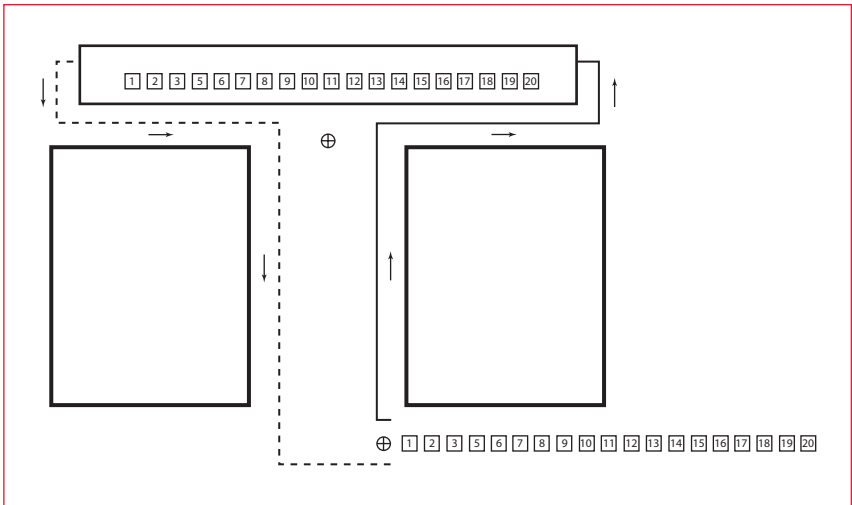
- b. As shown in Figure 9-3, the colour party, in single file, marches along the centre aisle. Upon reaching the head table area of the assembly, the file turns right, marches to the end of the head table, and must manoeuvre in a manner that will permit them to move behind the head table area to the applicable flag base. The Sergeant-at-Arms moves independently to a position in front of the head table area, halts and controls the Colour Party from this position;

---

**Note - BREAKING THE COLOURS – When the colours are being posted for large assemblies, meetings and conventions, if possible, they should be placed in such a position so that no one can Break the Colours by walking through them. Should this not be possible, then members are to walk around behind the colours to reach the stage or head table area, and not through them. At no time should members walk through the colours once they have been posted for Legion meetings or Conventions. The colours should also be placed in such a position as to not impede the sight line of the members attending meetings or conventions.**

---

- c. When the flag bases have been reached, the Colour Bearers mark time and the band ceases playing music. The Sergeant-at-Arms, ensuring that a standard pause is observed, orders "HALT ..... INWARDS TURN ..... DEPOSIT COLOURS";
- d. When the Colours are deposited in the flag bases and adjustments have been completed, the Sergeant-at-Arms orders "ATTENTION";
- e. The chair orders "COLOUR PARTY WILL RETIRE";
- f. The Sergeant-at-Arms orders "RIGHT TURN ..... QUICK MARCH". The band plays appropriate music. The file steps off, marches out in front of the head table area, and along the centre aisle to the rear of the assembly hall. The Sergeant-at-Arms marches to the rear of the Colour Party;
- g. The band ceases playing when the Colour Party reaches the rear of the assembly area where the Colour Party is halted and fallen out.

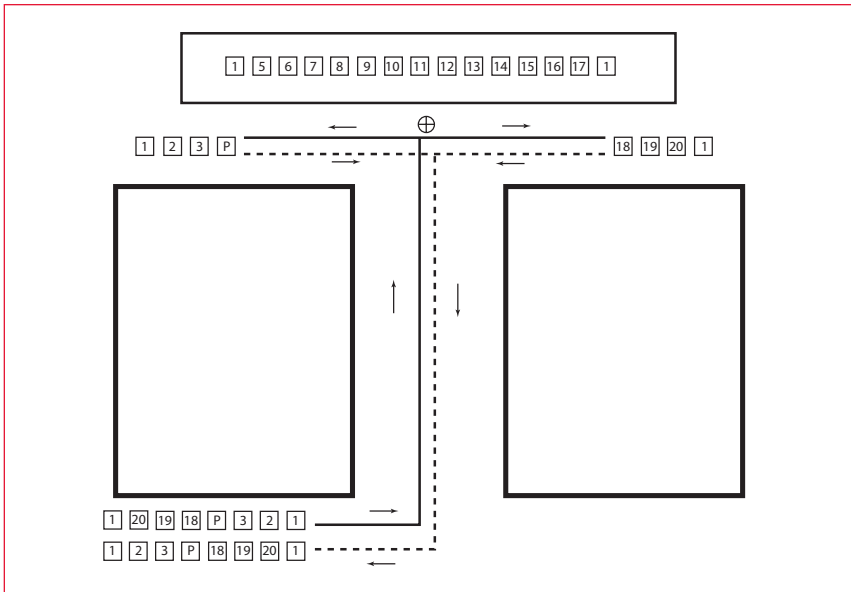


**Figure 9-3 — Placing/Recovering Colours (Large Assembly)**

**955. Marching Off The Colours.** To recover the Colours at the Closing Ceremony and upon direction from the Chair, the Colour Party marches in single file to, and is halted behind the Colour for which each bearer has responsibility. The Commands “RETRIEVE COLOURS ..... RIGHT TURN..... QUICK MARCH” are given. The Colour Party departs via the same route as they departed after depositing the colours at the Opening Ceremony. Music is played, and once the Colour Party has reached the rear of the assembly hall the Colour Party is ordered to “HALT” and the music ceases. The Sergeant-at-Arms dismisses the Colour Party.

### CONVENTIONS

- 956.** Prior to the opening of a convention the Provincial and Territorial flags that are not included with the Colours are positioned on the stage or, as circumstances may dictate, to the rear of the area set aside for the head table. A Canadian Flag is placed at each end of the line of flags. These flags remain in position for the duration of the Convention, Figure 9-4 refers.
- 957.** In preparation for the marching on of the Legion Colours, flag bases are positioned in front of the stage or head table area as indicated in Figure 9-4.



**Figure 9-4 — Placing/Recovering Colours (Convention)**

**958. Marching On The Colours.** Once the Convention has been called to order, the Chair will order "MARCH ON THE COLOURS". The Sergeant-at-Arms will order "CARRY COLOURS ..... QUICK MARCH". The colour party marches along the centre aisle of the room, in single file, carrying the flags in this order - 1, 2, 3, P, 18,19, 20 and 1. These are the only flags that are marched on and marched off at a Convention.

- a. On reaching the front of the stage or head table area, bearers 1, 2, 3 and P wheel left and bearers 18, 19, 20 and 1 wheel right. They continue marching to their positions behind the flag holders, halt and turn inward;
- b. The Sergeant-at-Arms orders "DEPOSIT COLOURS". The bearers deposit and adjust the Colours;
- c. The Sergeant-at-Arms orders "ATTENTION";
- d. The Chair orders "COLOUR PARTY WILL RETIRE";
- e. The Sergeant-at-Arms orders "LEFT AND RIGHT TURN..... QUICK MARCH";
- f. The bearers meet at the centre aisle of the room, make right and left wheels and continue marching to the rear of the assembly hall. The Sergeant-at-Arms marches at the rear of the Colour Party.

**959. Marching Off The Colours.** The procedure used to recover the Colours is the same as described at Section 956.

#### OTHER OCCASIONS

**960.** The procedures outlined above may be modified to suit local conditions.

#### ORDER OF PRECEDENCE

**961. Provincial and Territorial Flags.** If more than one Provincial or Territorial flag are paraded they must be displayed in their order of precedence. The order of precedence is as described at Section 908.

**962. United States.** The precedence of flags for Branches and posts in the United States is:

- a. The United States Flag;
- b. The Canadian Flag;
- c. The Red Ensign (1922 - 1957);
- d. The Royal Union Flag;
- e. The United Nations Flag;
- f. The NATO Flag;
- g. The Legion Banner.

#### THE BRANCH COLOUR PARTY

**963.** Branch Colour Party formations may be structured as shown in the following illustrations.



Figure 9-5A — "On the March"



Figure 9-5B — "In Line"

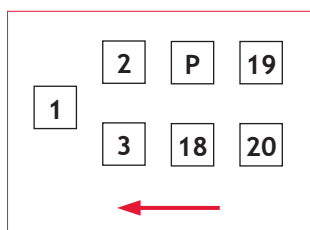
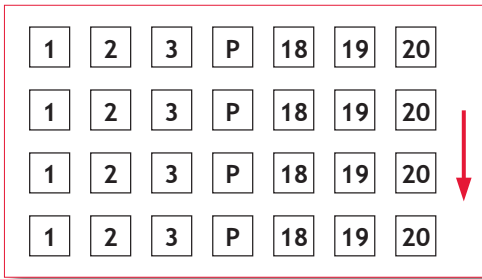


Figure 9-6 — "Form Lane"

#### MASSED BRANCH COLOUR PARTY

**964.** A massed Branch colour party proceeds as follows on the march.



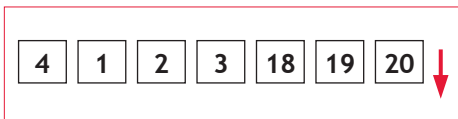
**Figure 9-7 — Massed Branch Colour Party**

### **JOINT BRANCH/POST PARADES**

965. In Canada, USA posts carry the American Flag (4) in the position of the provincial flag.



**Figure 9-8 — Joint Branch/Post Parades in Canada (Post)**



**Figure 9-9 — Joint Branch/Post Parades in USA (Both)**

966. In the USA, the American flag takes precedence for both the Branch and post colour parties. A provincial flag is not carried.

### **CONSECRATION OF COLOURS (DRUMHEAD SERVICE)**

#### **967. The Parade to the Location of the Ceremony.**

The parade FALLS-IN at an area adjacent to location of ceremony in two groups with the band (if available) on the right. The Colours are MARCHED-ON to a position in front of the band while the band plays appropriate music. The Parade is now ready for the MARCH-ON, Figure 9-10 refers.

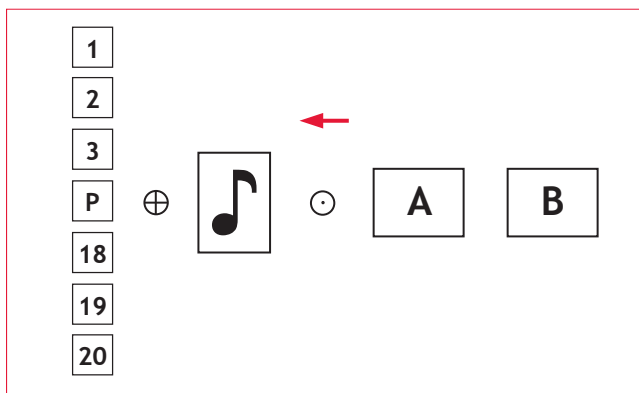


Figure 9-10 — Position for the March-on

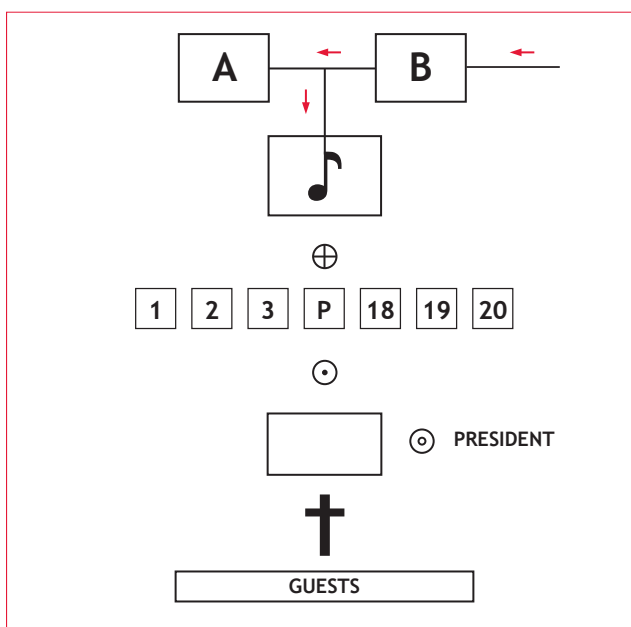


Figure 9-11 — Positions at Ceremony

- a. The Parade moves to the right and marches into position, Figure 9-11 refers;
- b. When all members are in position for the ceremony, the Colour Party Commander gives the command "ORDER COLOURS". The Parade Commander then orders "PARADE STAND AT EASE ... PARADE STAND EASY". The Colour Party acts on this order;
- c. **Procedure for the Ceremony.** The Parade Commander brings the Parade to "ATTENTION".



The Colours are brought to the Carry. The Parade Commander orders "PARADE SALUTE". The Band plays "*The Royal Anthem*", the officers in charge salute;

- d. The Branch president moves from a position on the right side of the altar (constructed from the drums) to a position in front. The order is then given "PLACE COLOURS". On this order the flags individually and, in the sequence that follows - the Legion Banner, the NATO Flag, the UN Flag, the Provincial/territorial Flag, the Royal Union Flag, the Red Ensign and the Canadian Flag - are taken from the Colour Bearers by the Colour Party Commander and handed to the Branch President, who places them on the altar. The Colour Party Commander returns to his designated position;

**THE PARADE COMMANDER:** *(addresses the Chaplain)*

**On behalf of The Royal Canadian Legion, will the Chaplain bid God's blessing on the Colours.**

**THE CHAPLAIN:**

We are ready to do so.

**THE PARADE COMMANDER:**

**PARADE REMOVE HEADDRESS ... STAND AT EASE ...  
STAND EASY.**

- e. The Chaplain performs the Consecration Ceremony.

**On completion of the Consecration Ceremony, the Chaplain moves to the front of the altar;**

**THE PARADE COMMANDER:**

**PARADE ATTENTION ... REPLACE HEADDRESS ... STAND AT EASE ... STAND EASY.**

*(The members on parade adjust their headdress)*

**THE PARADE COMMANDER:**

**PARADE ATTENTION.**

- f. The Chaplain removes the flags from the altar in the following sequence - the Canadian Flag, the Red Ensign, the Royal Union Flag, the Provincial/territorial Flag, the United Nations Flag, the NATO Flag and the Legion Banner. They pass each flag to the Branch President individually who accepts each flag in a kneeling position with the right knee on the ground. As each flag is received the Branch

President rises and places the flag in the sling of the Colour Bearer. Each flag is accepted at the CARRY;

- g. When all flags have been returned to the Colour Bearers;

**THE PARADE COMMANDER:**

**PARADE SALUTE.**

- h. The Band plays "*O Canada*"; the officers in charge salute. On completion of "*O Canada*", the salute is completed.

**969. The March Past.** (see Figure 9-12) The Parade Commander orders all groups to turn right. The Colour party moves to its position ahead of the first group. The officers take up their positions. The Band stands firm. The Parade Commander orders the Parade to MARCH PAST. The standard order is:

**THE ROYAL CANADIAN LEGION WILL MARCH PAST IN COLUMN OF ROUTE..... BY THE RIGHT.... QUICK.... MARCH.**

- a. When the Parade has moved off, the Band steps off and marches at the rear of the Parade;
- b. Upon reaching the first saluting marker, the contingents perform an EYES RIGHT in succession of contingents, the officers in charge salute, and the Colours are let fly;
- c. Upon reaching the second marker, the contingents are given an EYES FRONT in succession by contingent, the officers in charge complete their salute, and the Colours are CAUGHT;
- d. The Parade marches to the location where it was formed, the Colours are MARCHED-OFF, and the Parade is DISMISSED.

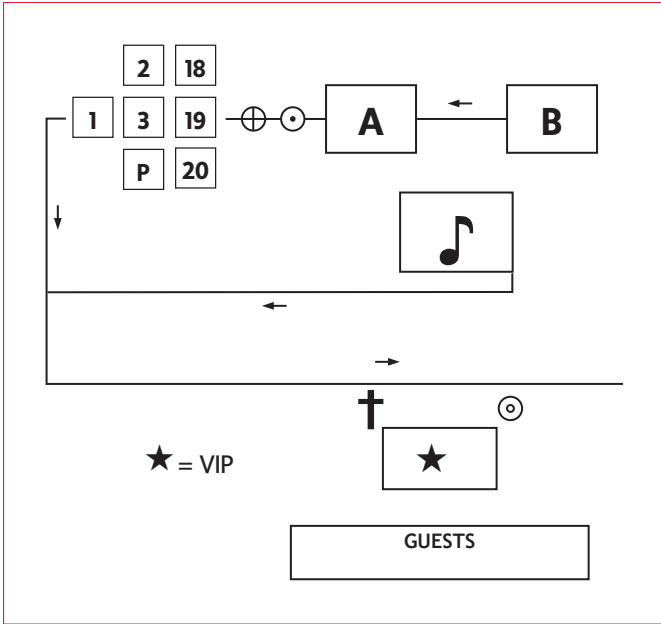


Figure 9-12 — March Past

# Basic Drill Movements

## WORDS OF COMMAND

**1001.** Words of command must be given in a clear and loud voice that is precise. The commands are given in two distinct parts with a short pause between each. They are:

- a. The Cautionary Command which notifies the comrades that a drill movement will occur;
- b. The Executive Command which is a short, sharp order that directs the comrades to perform the drill movement;
- c. Examples of Cautionary and Executive Commands are;

<b>Cautionary</b>	<b>Executive</b>
ATTENNNNNNNN	SHUN
COLOUR PARTY CARRYEEEE	COLOURS
PARAAADE	HALT

- d. When large groups are parading it is normal to provide an additional warning order to ensure that all are aware of what is about to happen. An example is -

PARAAADE      ATTENNNNN      SHUN

**1002.** When on the march, executive orders must be given at precisely the right moment. For example:

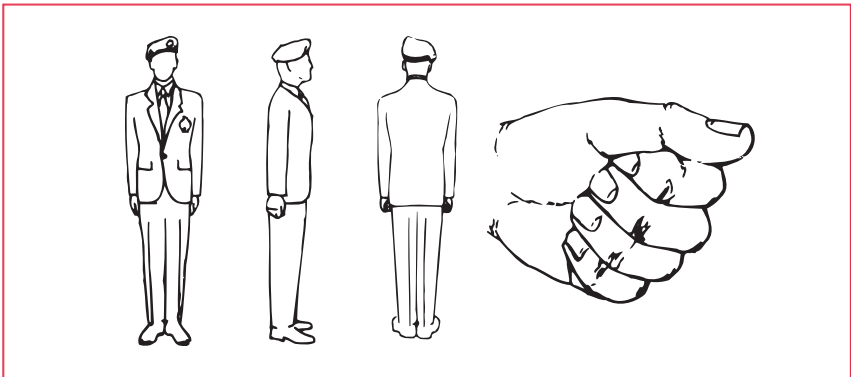
- a. HALT, EYES RIGHT/LEFT/Front, RIGHT TURN/INCLINE and FORWARD are given as the left foot is forward and on the ground;
- b. LEFT TURN/INCLINE, ABOUT TURN and MARK TIME are given as the right foot is forward and on the ground.

**1003.** There is a skill to giving drill orders which is a combination of self confidence, voice projection and timing. This skill can be achieved through practice and experience.

## BASIC DRILL MOVEMENTS

**1004. Position of Attention - Figure 10-1.** The position of attention is one of readiness in expectation of a word of command. Alert exactness in this position is important and, therefore, members should not be kept at attention longer than necessary. At the position of attention:

- a. The heels are together and in line;
- b. The feet are turned out to form an angle of 30 degrees;
- c. The body is balanced and weight is evenly distributed on both feet;
- d. The shoulders are level, square to the front;
- e. The arms are hanging as straight as their natural bend will allow with elbows and wrists touching the body;
- f. The wrists are straight, the back of the hands held outwards;
- g. The fingers are aligned, touching the palm of the hand, thumbs placed on the side of the forefingers at the middle joint with the thumbs and back of the fingers touching the thighs lightly and the thumbs in line with the seam of the trousers;
- h. The head is held erect, neck touching the back of the collar, eyes steady, looking at their height, and straight to the front;
- i. No part of the body should be strained.



**Figure 10-1 — Attention**

**1005. Position of the Stand at Ease - Figure 10-2.**

The position of standing at ease is an intermediate position between attention and standing easy. It allows no relaxation, but can be maintained, without strain, for a longer time than the position of attention.

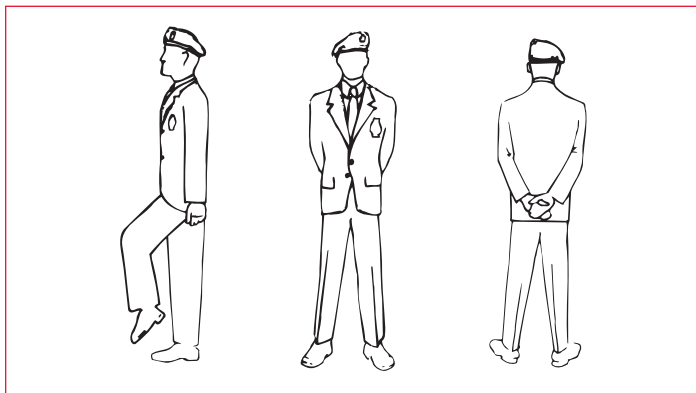
**1006.** On the command "STAND AT - EASE":

- a. Bend the left knee;
- b. Carry the left foot to the left, straightening it in double time, and place it smartly flat on the ground, with the inside of the heels 10 inches (25 cm) apart;
- c. Simultaneously, with a quick motion, bring the arms behind the back, stretched to their full extent, and place the back of the right hand in the palm of the left, with thumbs crossed right over left, the fingers together and extended;
- d. Balance the body with the weight evenly distributed on both feet.

**1007. Stand Easy.** The position of stand easy is ordered when it is desirable to permit the members to relax. This command is only given when the members are in the position of stand at ease.

**1008.** On the command "STAND - EASY":

- a. Close the hands and bring the arms to the position of attention;
- b. Following a standard pause, relax.



**Figure 10-2 — Stand at Ease**

**1009. Stand at Ease from Stand Easy.** On a cautionary command such as "ROYAL CANADIAN LEGION", "COLOUR PARTY", "PARADE", etc., assume the position of stand at ease.

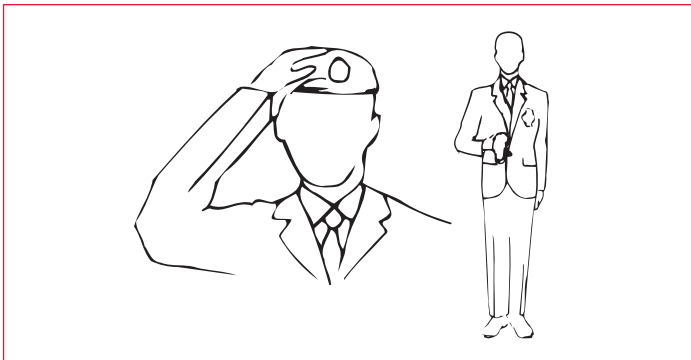
**1010. Attention from Stand at Ease.**  
On the command "ATTEN - TION":

- a. Bend the left knee and shift balance to the right foot;
- b. Straighten the left leg in double time, place the foot smartly on the ground, toe touching first, followed by the heel, and with heels aligned;
- c. Simultaneously, with a quick motion, bring the arms and hands to position of attention.

**1011. Remove Headdress - Figure 10-3.** The order to remove headdress may be given when it is customary to do so. This practice is normally performed at the call of the Parade Commander, Sergeant-at-Arms or person in charge.

**1012.** On the command "REMOVE - HEADDRESS":

- a. Bring the right hand to the front of the headdress by the shortest route;
- b. Grasp the headdress between the thumb and fingers, with the fingers aligned and parallel to the shoulders as much as practicable;
- c. After the standard pause, maintaining the bend in the right arm, cut the upper arm to the right side of the body and the forearm parallel to the ground;



**Figure 10-3 — Remove Headdress**

- d. Bring the right hand to the centre of the body;
- e. Maintaining the grasp on the headdress, hold the headdress above the hand and in the centre of the body.

**1013. Replace Headdress.**

On the command "REPLACE -HEADDRESS":

- a. Replace the headdress using both hands;

- b. Following a standard pause, resume the position of attention by cutting both arms to the side;
- c. Comrades are then ordered to "STAND AT - EASE ... STAND - EASY", at which time they adjust their headdress.

## COMPLIMENTS AND WREATH-LAYING PROCEDURES

**1014. Hand Saluting.** With the paying of Compliments being formal marks of trust and courtesy, the military hand salute is noted as a traditional demonstration of showing respect and in particular, respect for office. Although the method of saluting varies under the circumstances, the paying of compliments is a fundamental requirement that is indispensable to service discipline.

### **1015. Method.**

- a. Unification of the Canadian Armed Forces brought us a different method of hand salute, with the head held high, bringing the right hand smartly to a position over the right eyebrow, with the palm facing down, the fingers fully extended and the elbow perpendicular to the shoulder. The motion is short way up – short way down. The Royal Canadian Legion has adopted this method. Saluting with arms is an entirely different discipline and because members don't usually salute with arms, this section will deal only with the Hand Salute;
- b. So, while methods do vary, a couple of things remain constant in delivering a Hand Salute;
  - i. The compliment is always offered by the junior ranking person to an officer or another senior positioned person. The person receiving the compliment will acknowledge the salute by returning it, providing that they are in uniform and wearing headdress. If not in uniform or in uniform but not wearing headdress, they will acknowledge the compliment by standing or sitting at attention for a brief moment;
  - ii. The Hand Salute is never offered unless the junior ranking person is in uniform complete with headdress. If not wearing headdress, the compliment will be offered by smartly



coming to attention until the compliment is acknowledged.

- c. In Canada, military compliments are only officially paid to the Sovereign; the Governor-General; members of the Royal Family; recognized foreign royalty; foreign heads of state or government; the Prime Minister; the Minister and Associate Minister of National Defence; Lieutenant-Governors and commissioned Officers as well as notable exceptions;
- d. There are, of course, many exceptions including Remembrance parades; dealing with flags; at funeral services, etc. For those interested in the exceptions as they apply to the military, you can search on the internet for, "**THE CANADIAN ARMED FORCES MANUAL OF DRILL AND CEREMONIAL**" and you'll find them.

#### 1016. **Legion Saluting.**

- a. The Legion, of course, recognizes saluting to be a form of presenting a greeting and paying respect and as noted the Legion adopted the current Canadian Armed Forces form of the Hand Salute;
- b. For Legion purposes, saluting when wearing headdress will or will not be done on the following occasions;
  - i. Legion Officers in charge of formed parties or groups will salute during the playing of "**O Canada**", "**Last Post**", "**Rouse**", the "**Royal Anthem**" and/or the "**Vice Regal Salute**" and during the march past;
  - ii. Legion members in Legion Dress, wearing headdress, who are spectators at an event and are not part of a formed body will salute during the playing of "**O Canada**"; "**Last Post**"; "**Rouse**"; the "**Royal Anthem**" and/or the "**Vice Regal Salute**". It is also customary to salute the Colours as they are being marched past;
  - iii. Members formed up on parade and who are within a formed body shall not salute during the playing of "**O Canada**", "**Last Post**", "**Rouse**", the "**Royal Anthem**" and/or the "**Vice Regal Salute**" nor during the march past. During a march past, these members, with the exception of those carrying colours in colour

- parties, will react to the command, “EYES RIGHT” or “EYES LEFT”;
- iv. Further, members within a “Formed Body” shall not salute when Colours and/or the National Flag are paraded before the group. Only the senior member in charge of the group will salute;

---

**Definition: A formed body is a parade structure of 2 or more ranks with a Senior member in charge.**

---

- v. Salutes will not be held during the “Silence”;
- vi. Procedures for saluting at Funeral Services/ Graveside Services are noted in this manual at Chapter 7;
- vii. There may be other circumstances that require members to offer compliments. Members are advised to consult “*THE CANADIAN ARMED FORCES MANUAL OF DRILL AND CEREMONIAL*” for guidance.

**1017. Why is it that Legion officers are rarely saluted?**

- a. Legion Officers are certainly saluted when they are reviewing parades, however, the likely answer is that we traditionally drop our rank at the door when we join the Legion. The secondary likely answer is that most current Legion Officers are not “commissioned officers” as prescribed in Canadian Armed Forces regulations;
- b. In certain circumstances, normally parade oriented, it is appropriate for a Legion member to salute a Senior Legion Member or Military Officer/ Dignitary out of respect for the Senior Office.

**1018. Wreath laying.**

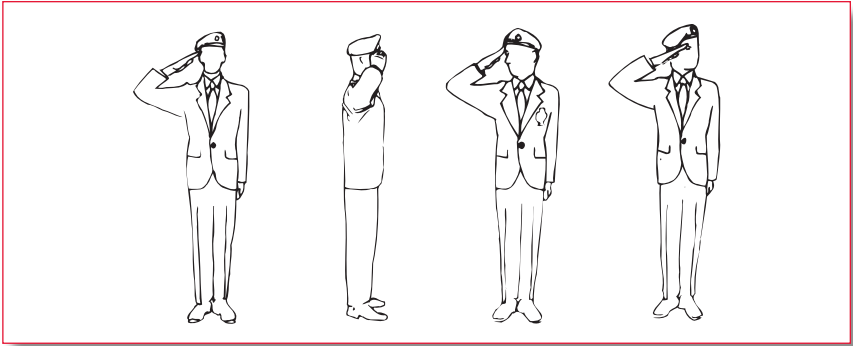
- a. There are many occasions when members will be called upon to either place a wreath or to be a wreath bearer. When placing a wreath, the person placing the wreath and the bearer should march together to the memorial or cenotaph, with the bearer slightly behind and to the left of the person placing the wreath. In certain circumstances, it would be permissible for the wreath bearer to march to the right of the person laying the wreath if that person required assistance to the designated area where the wreath is to be placed. The individuals will halt and the bearer will hand

the wreath, with the ribbon or banner facing the person laying the wreath. The wreath layer will step forward if necessary and place the wreath in the designated location. Upon placing the wreath, the wreath layer and the bearer take one step backward, salute, turn right and march back to their position;

- b. In some ceremonies, poppies are laid on wreaths that have been placed for that purpose. If this is to be the case, then the person placing the poppy shall march up to the wreath, halt and kneel forward and place the poppy. After the poppy has been placed on the wreath, the person shall resume the position, take one-step backward, salute, turn right and march back to their position;
- c. The above-noted wreath-laying procedures are appropriate for outdoor or indoor cenotaph services, providing that the bearer is wearing headdress. For any Legion purpose, members not wearing headdress shall not salute but will acknowledge the situation by coming smartly to the position of attention.

**1019. Saluting at the Halt** - Figure 10-4. To perform a salute:

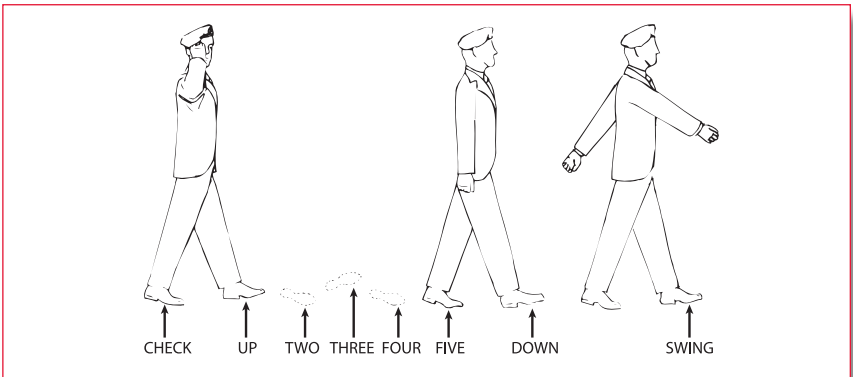
- a. Bend the right elbow and open the palm of the right hand;
- b. Force the right hand by its shortest route to the forehead so that;
  - i. The palm of the hand is facing down;
  - ii. The thumb and fingers are fully extended and close together;
  - iii. The tip of the second finger is one inch (2.5 cm) above and in line with the outside of the right eyebrow;
  - iv. The hand, wrist, and forearm are in a straight line;
  - v. The elbow is in line with the shoulders;
  - vi. The upper arm is parallel to the ground.
- c. To complete the salute, bring the hand sharply to the position of attention by the shortest route without slapping the thigh, closing the hand after the forearm is lowered below the shoulder level.



**Figure 10-4 — Saluting at the Halt**

**1020. Saluting on the March** - Figure 10-5. On the march, the mechanics of the salute are the same as for Saluting at the Halt, but includes the following movements:

- a. Complete a 30 inch pace with the right foot;
- b. Complete a 30 inch pace with the left foot;
- c. Cut the left arm to the side;
- d. Simultaneously, cut the right arm to the side and then up to the salute in one continuous movement, turning the head right/left as far as possible without straining, as applicable;
- e. The left arm remains stationary throughout the salute;
- f. To complete the salute complete a 30 inch pace with the right foot; and cut the right arm to the side, turning the head and eyes to the front and continue marching.



**Figure 10-5 — Saluting on the March**

1021. **Eyes Right/Left** – Figure 10-6. On the command "EYES - RIGHT/LEFT":

- a. Complete a 30 inch pace with the right foot;
- b. Complete a 30 inch pace with the left foot;
- c. Simultaneously turn the head and eyes to the right/left as far as possible without straining;

---

**NOTE: On occasions when the command "EYES-RIGHT/LEFT" is given to a marching contingent, the command does not apply to members of a colour party who are carrying colours. Colour bearers are to face forward at all times.**

---

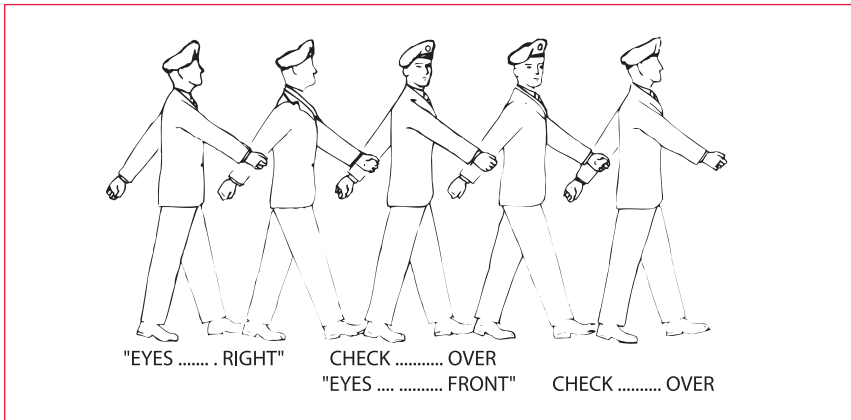
- d. Look directly into the eyes of the personage being saluted;
- e. Continue swinging the arms;

---

**NOTE: The leading person on the directing flank (the right or left marker) shall maintain the head and eyes to the front to keep direction. The person in command of the group salutes.**

---

- f. On the command "EYES - FRONT";
  - i. Complete a 30 inch pace with the right foot;
  - ii. Complete a 30 inch pace with the left foot;
  - iii. Simultaneously, cut the head and eyes smartly to the front.



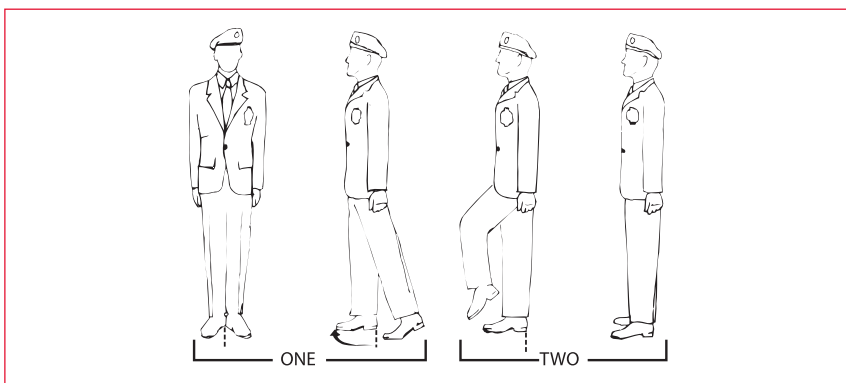
**Figure 10-6 — Eyes Right**

**1022. Turning at the Halt - Figures 10-7 and 10-8.**

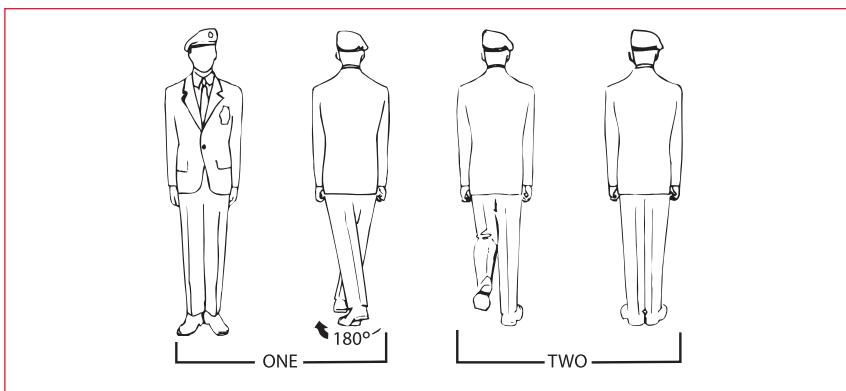
On the command

“RIGHT - TURN”:

- a. Brace both knees, arms are at the sides and body erect;
- b. Turn 90 degrees to the right by pivoting on the right heel and left toe, simultaneously, raising the left heel and right toe;
- c. On the completion of the movement, place the weight of the body on the right foot and brace the left leg with the heel off the ground;
- d. Following a standard pause, bend the left knee, straightening it in double time, smartly placing the left foot beside the right to assume the position of attention;



**Figure 10-7 — Right Turn at the Halt**

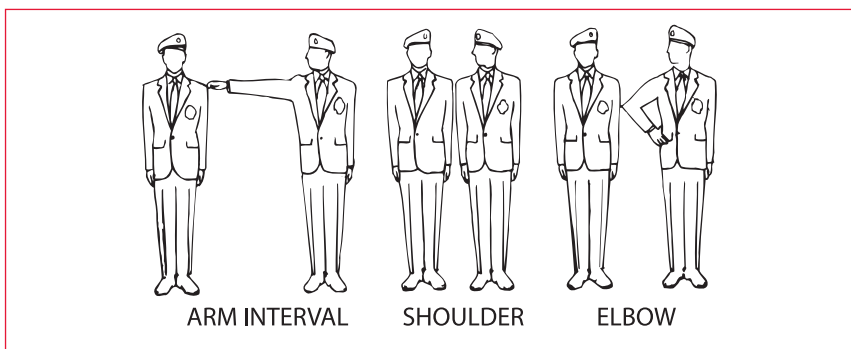


**Figure 10-8 — About Turn at the Halt**

- e. The "LEFT - TURN" is achieved through the same movements, using the opposite feet and directions;
- f. The "LEFT/RIGHT - INCLINE" is completed doing the same movements; however, the turn is only 45 degrees;
- g. The "ABOUT - TURN" is the same as for the right turn except that the pivot to the right is made through 180 degrees. Balance is maintained by bracing the legs and locking the thighs.

**1023. Dressing** - Figure 10-9. On the command "RIGHT - DRESS":

- a. The right hand member of the front rank stands fast
- b. Following a standard pause, the right file stands fast while the remainder turns head and eyes to the right as far as possible without straining;
- c. Simultaneously, the front rank, except for the right-hand member, shoots the right arm its full extent behind the shoulder of the member on the right, hand closed as in the position of attention, back of the hand upwards and arm parallel to the ground;
- d. Following a standard pause, the right-hand member of the front rank stands fast while the remainder takes up correct alignment, distance and covering, taking short, quick paces until they are in the correct position, movement starting with the left foot. The distance is correct when the right hand touches the left shoulder of the person on the right.



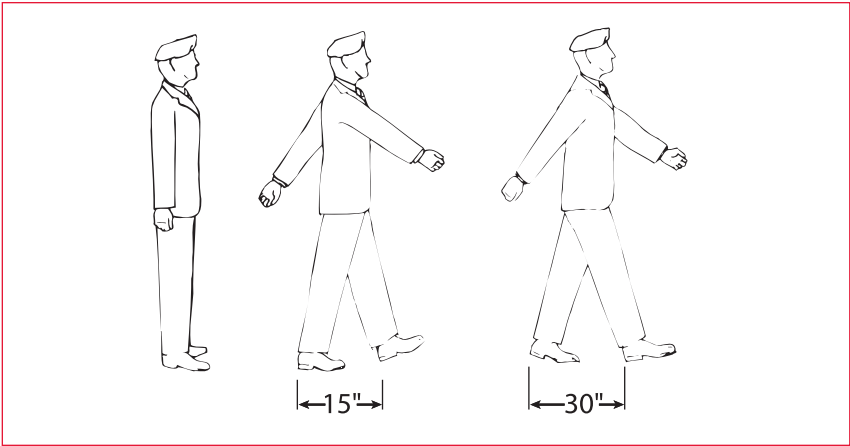
**Figure 10-9 — Dressing**

**1024.** As a guide to taking up correct alignment, each member, except those in the right file, moves to a position from which the lower portion of the face

of the second person to the right can just be seen. Correct covering is taken up by glancing to the front without moving the head.

- 1025.** Dressing can be performed in one of three formats:
- a. Standard dressing, as described in the previous sections;
  - b. "ELBOW DRESSING ... RIGHT - DRESS";
    - i. The front rank, except for the right-hand member, places the right hand on the hip, fingers closed, pointed down and extended forward, thumb to the rear and elbow straight out to the side;
    - ii. The point of the elbow touches the member on the right when the distance is correct.
  - c. "SHOULDER DRESSING ... RIGHT - DRESS" - each person's arms remain at the position of attention and the correct distance only allows enough room between members for freedom of movement.
- 1026.** On the command "LEFT - DRESS" - the same drill movements are followed except the head and eyes are turned left and the left arm is used. The left-hand member/file stands fast, as applicable.
- 1027.** When dressing is complete, the command "EYES - FRONT" is given. Members shall snap heads and eyes to the front and, as applicable, cut arms smartly to the position of attention without slapping the thighs.
- 1028. **Marching and Halting in Quick Time - On The March**** - Figure 10-10. When marching, comrades shall maintain the body erect with head and eyes to the front.
- 1029.** On the command "QUICK - MARCH":
- a. Shoot the left foot forward one 15 inch pace, striking the heel on the ground first and keeping the toe pointed directly forward;
  - b. Simultaneously, swing the right arm straight forward and the left straight to the rear, waist high;
  - c. Continue marching with subsequent paces of 30 inches each;
  - d. Swing the arms forward successively in a straight line from the shoulder, front to rear, with hands closed as in the position of attention;
  - e. Maintain dressing by the directing flank.

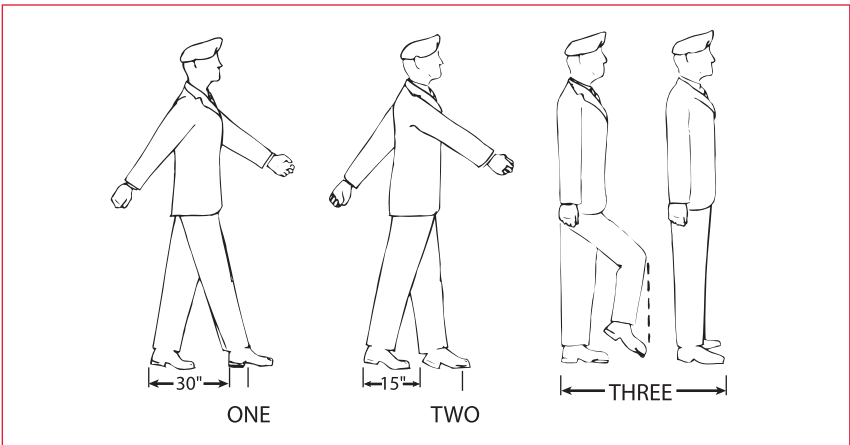




**Figure 10-10 — Marching in Quick Time**

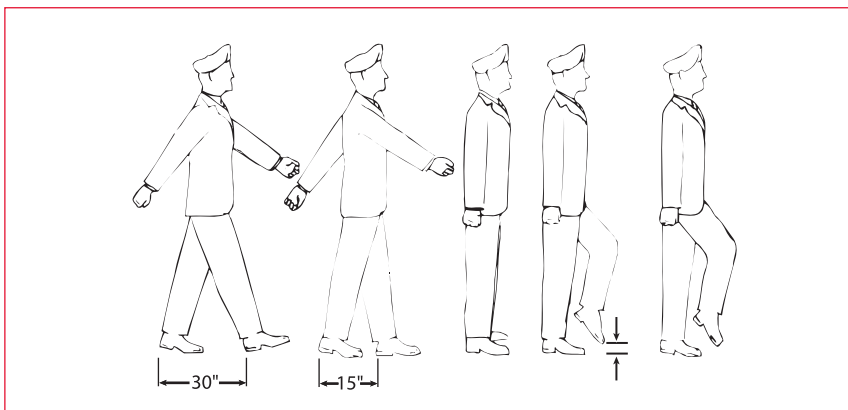
**1030. Marching and Halting in Quick Time - The Halt** - Figure 10-11. On the command "HALT":

- a. Check the forward movement by placing the right foot flat on the ground naturally, using the heel as a brake;
- b. Take a 15 inch pace with the left foot, placing it flat on the ground;
- c. Bend the right knee, straightening it in double time;
- d. Simultaneously, cut the arms to the sides as quickly as possible and assume the position of attention.



**Figure 10-11 — Halting in Quick Time**

- 1031. Marking Time - Figure 10-12.** Marking time in quick time is carried out at the same cadence as marching in quick time. On command "MARK - TIME":
- Take a 15 inch pace with the left foot, placing the foot flat on the ground naturally;
  - Bring the right foot into the left in a straight-leg manner, not scraping the ground;
  - Simultaneously, cut the arms to the sides, assuming the position of attention;
  - Continue to mark time, maintaining the same cadence, placing the toe on the ground before the heel as each leg is lowered;
  - Continue to mark time until the command "FOR - WARD" or "HALT" is given.

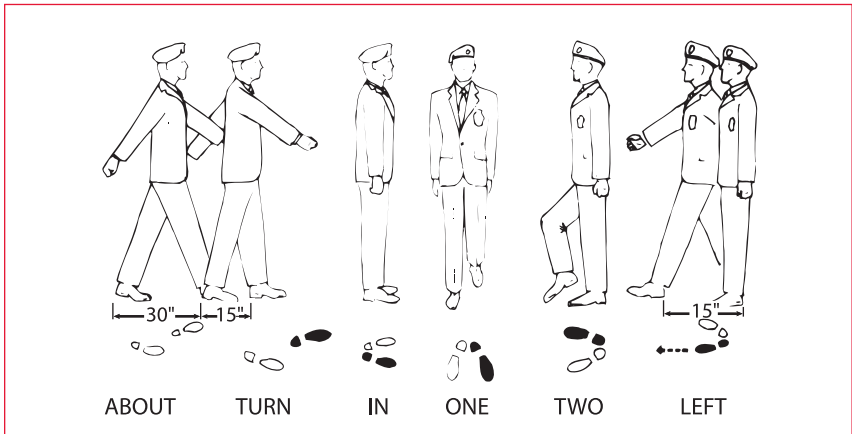


**Figure 10-12 — Marking Time from Quick Time**

- 1032.** On the command "FORWARD":
- Straighten the right leg and assume the position of attention;
  - Shoot the left foot forward one 15 inch pace;
  - Continue marching in quick time, swinging the right arm forward and the left arm to the rear.
- 1033.** On the command "HALT":
- Take a further mark time pace with the right foot;
  - Take a further mark time pace with the left foot;
  - Straighten the right leg in double time, assuming the position of attention.

**1034. Turns on the March in Quick Time** - Figures 10-13 and 10-14. On the command "ABOUT - TURN":

- a. Take a 15 inch pace with the left foot;
- b. Bring the right foot in to the left foot in a straight-leg manner above the ground, to the position of attention;
- c. Simultaneously, cut the arms to the sides and maintain them there throughout the turn;
- d. Pivot on the sole of the right foot to force the body through a turn of 90 degrees to the right, simultaneously bending the left knee;
- e. Lower the left leg smartly to the ground to assume the position of attention;
- f. Pivot on the sole of the left foot to force the body through a turn of 90 degrees to the right, simultaneously bending the right knee;
- g. Lower the right leg smartly to the ground to assume the position of attention;
- h. Take a 15 inch pace with the left foot in the new direction and continue marching.

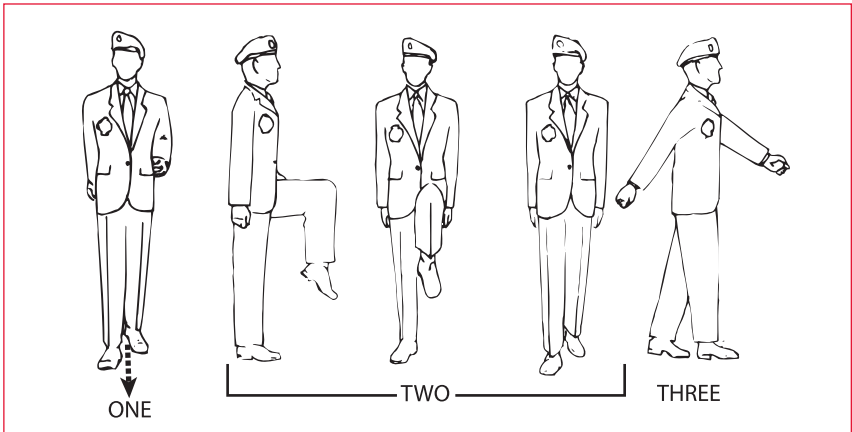


**Figure 10-13 — About Turn on the March in Quick Time**

**1035. On the command "RIGHT - TURN":**

- a. Complete a 15 inch pace with the right foot;
- b. Cut the arms to the side as in the position of attention;
- c. Pivot on the sole of the right foot to force the body through a turn of 90 degrees to the right, simultaneously bending the left knee;

- d. Straighten the left leg as in the position of attention;
- e. Keep the body and head held up and the arms, body and head steady;
- f. Immediately shoot the right foot forward in a 15 inch pace with the toe just clear of the ground and continue marching.

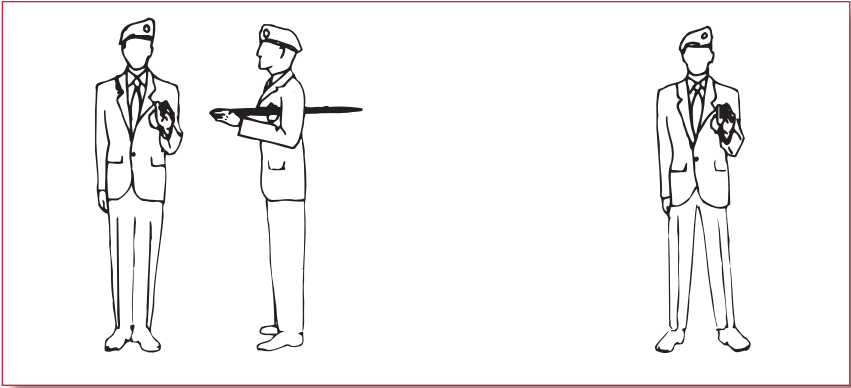


**Figure 10-14 — Left Turn on the March in Quick Time**

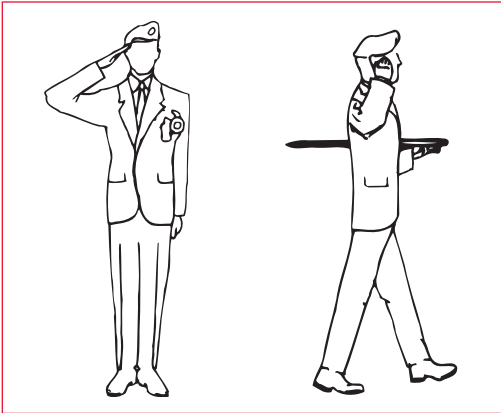
**1036.** On the command “LEFT - TURN”:

- a. Complete a 15 inch pace with the left foot;
- b. Cut the arms to the sides as in the position of attention;
- c. Pivot on the sole of the left foot to force the body through a turn of 90 degrees to the left, simultaneously bending the right knee;
- d. Straighten the right leg and assume the position of attention;
- e. Keep the body and head held up and the arms, body and head steady;
- f. Immediately shoot the left foot forward in a 15 inch pace with the toe just clear of the ground and continue marching.

**1037. Pace Stick Drill - Figures 10-15 and 10-16.** The Sergeant-at-Arms may carry a pace stick and all drill movements are to be carried out in a deliberate and smart manner.



**Figure 10-15 — Holding the Pace Stick at Attention/at Ease**



**Figure 10-16 — Saluting With a Pace Stick**

# COLOUR PARTY DRILL

## GENERAL

1038. Colour Party drill movements are performed in unison and the timing between movements is two marching paces in quick time.
1039. The distance between ranks of the Colour Party is four paces.
1040. Figure 10-17 depicts a Colour Bearer at the position of Carry Colours.

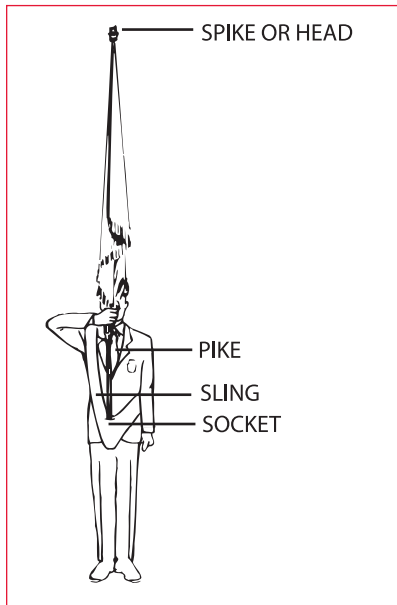


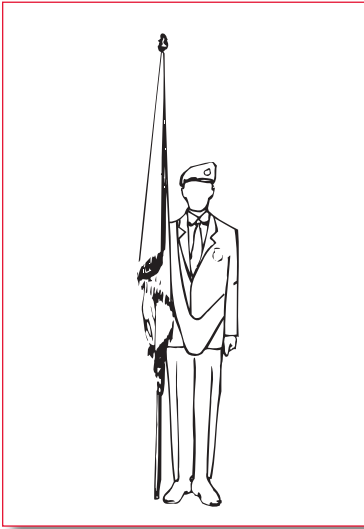
Figure 10-17 — Colour Bearer

## COLOUR PARTY DRILL MOVEMENTS

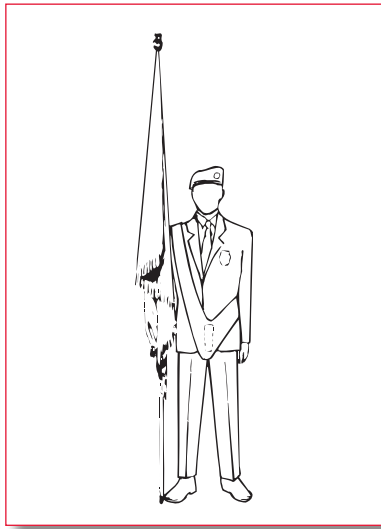
1041. **Position of the Order** - Figure 10-18. At the Order:
- The Colour Bearer is at attention;
  - The pike is held in a vertical position with the right hand at the right side of the body. The base of the pike is on the ground at the right side of the right foot, in line with the toe of the shoe;
  - The pike and Colour are held with an all-round grasp of the right hand, back of the hand outwards,

at the point of the pike where the lowest corner of the Colour reaches;

- d. The Colour shall hang naturally down the pike and shall not be stretched tight;
- e. The right elbow is at the side;
- f. The right wrist is directly in rear of the pike.



**Figure 10-18 — The Order**



**Figure 10-19 — At Ease**

**1042. Stand at Ease From the Order** - Figure 10-19.

On the command "STAND AT - EASE":

- a. Move the left foot in the normal manner;
- b. Keep the Colour and pike unmoved in the same position as described for the Order.

**1043. Stand Easy From Stand at Ease.**

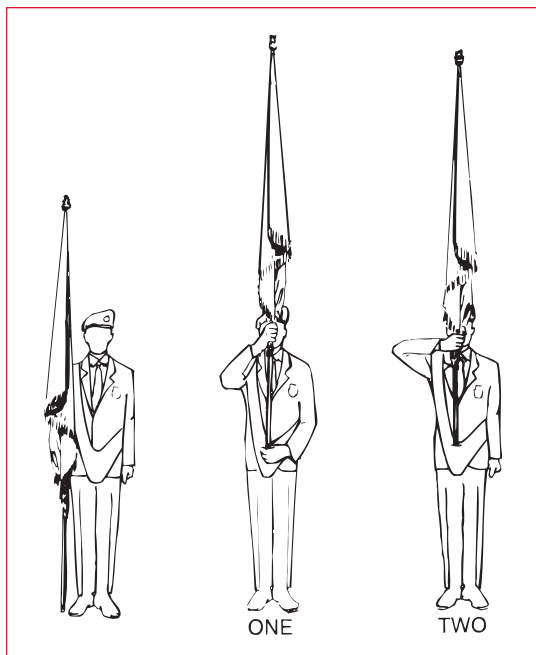
On the command "STAND - EASY":

- a. The Colour and pike remain in the same position;
- b. The left arm is kept to the side;
- c. The body is relaxed, but the feet and Colour are not moved.

**1044. Order From Stand at Ease.** On the command "ATTEN - TION", move the left foot in the normal manner.

**1045. Carry From the Order** - Figure 10-20.

On the command "CARRY - COLOURS":



**Figure 10-20 — Carry from the Order**

- a. With the right hand, raise the Colour to a vertical position in front of the centre of the body, keeping the base of the pike just clear of the socket of the sling with the right forearm alongside the pike;
  - b. Simultaneously, bring the left hand to the socket of the sling and guide the pike into the socket;
  - c. Bring the left hand to the position of the Order;
  - d. Simultaneously, raise the right forearm parallel to the ground; thus on completion of the movement.
    - i. The right hand is opposite the mouth;
    - ii. The right forearm is parallel to the ground at a right angle to the pike;
    - iii. The wrist of the right arm is straight;
    - iv. The back of the hand is outwards;
    - v. The head and eyes are facing the front.
- 1046.** In halls with low ceilings, on the command "CARRY - COLOURS":
- a. With the right hand, raise the Colour to a vertical position with the base of the pike clear of the floor;

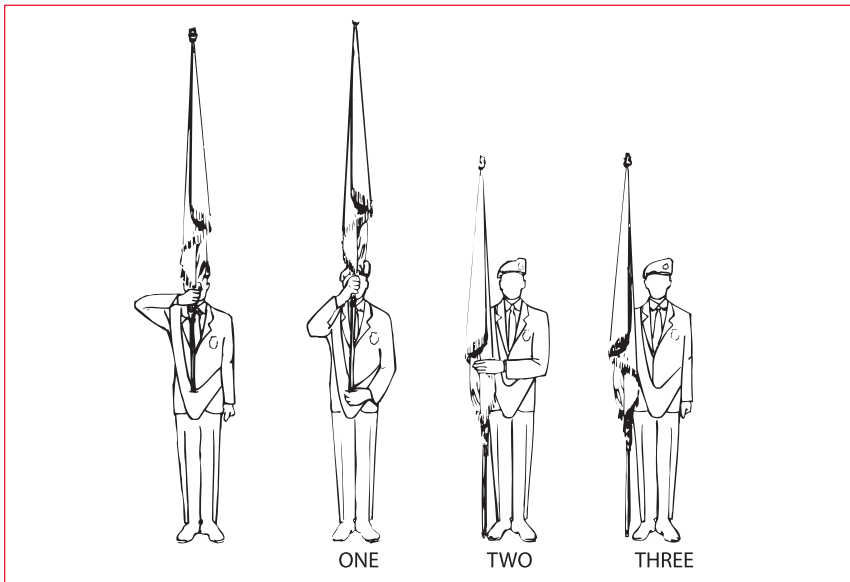


- b. At the same time, move the open left hand across the body to steady the Colour and the pike, with the back of the hand facing outward;
- c. The use of slings and gauntlets is optional.

**1047. Order From the Carry** - Figure 10-21.

On the command "ORDER - COLOURS":

- a. With the right hand, raise the pike clear of the socket of the sling, bringing the right forearm from the horizontal position to a vertical position alongside the pike;
- b. Simultaneously, bring the left hand to the socket to steady the pike and sling;
- c. Carry the Colour with the right hand to the position of the Order;
- d. Move the left hand across the body to steady the pike;
- e. On completion of the movement:
  - i. The back of the left hand shall be outwards;
  - ii. The fingers of the left hand are extended and pointing to the right;
  - iii. The left forearm is parallel to the ground.
- f. Cut the left hand to the side to the position of attention.

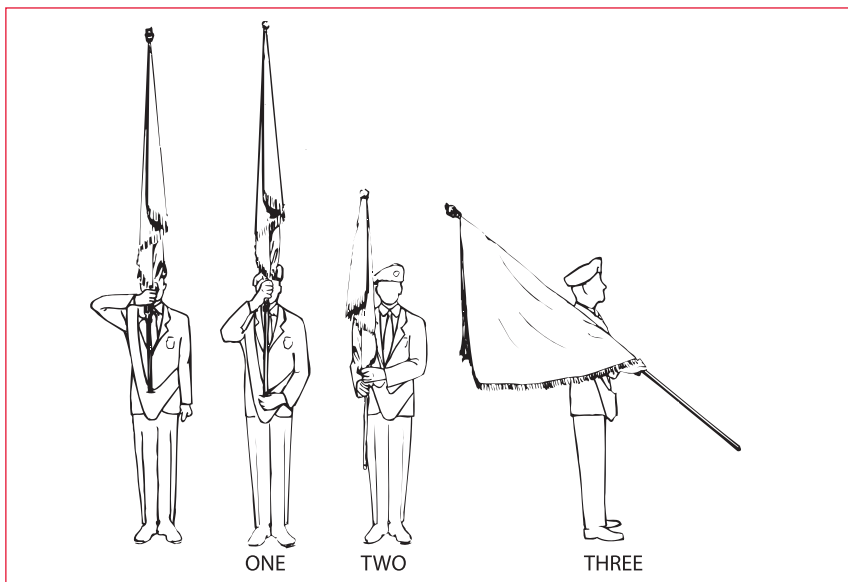


**Figure 10-21 — Order from the Carry**

**1048. Slope From the Carry - Figure 10-22.**

On the command "SLOPE - COLOURS":

- a. With the right hand, raise the pike clear of the socket of the sling, bringing the right forearm from the horizontal position to a vertical position alongside the pike;
- b. Simultaneously, bring the left hand to the socket to steady the pike;
- c. Lower the Colour with the right hand to the right shoulder;
- d. Simultaneously, with the left hand, grasp the pike above the right hand, with an all-round grip, to steady the pike;
- e. On completion of the movement;
  - i. The Colour shall be at a 45 degree angle on the right shoulder;
  - ii. The elbow shall be close to the body;
  - iii. The right forearm shall be parallel to the ground;
  - iv. The Colour shall hang over and cover the right shoulder and arm;
  - v. The pike shall not show between the hand and the shoulder and shall be covered by the Colour.
- f. Cut the left hand to the side to the position of attention.

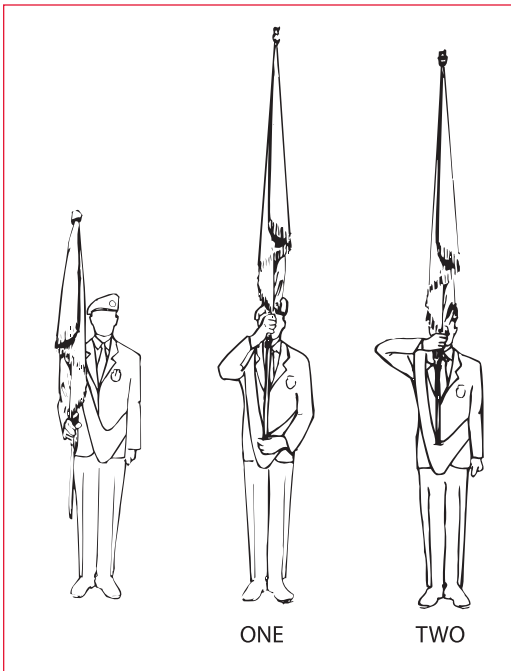


**Figure 10-22 — Slope from the Carry**

**1049. Carry From the Slope** - Figure 10-23.

On the command "CARRY - COLOURS":

- a. Raise the Colour off the right shoulder with the right hand to the perpendicular position of the Carry from the Order;
- b. Simultaneously, bring the left hand to the socket to guide the base of the pike into the socket;
- c. Cut the left hand to the side to the Carry position.

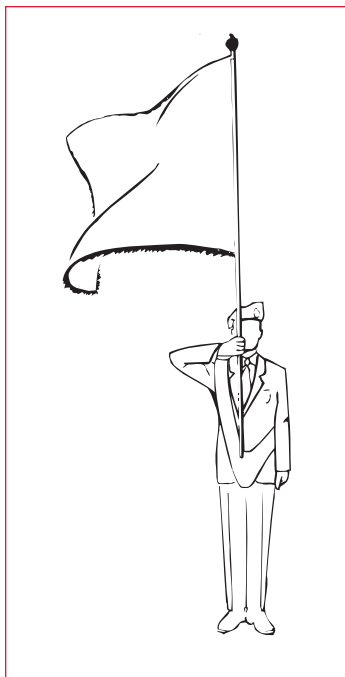


**Figure 10-23 — Carry from the Slope**

**1050. Let Fly From the Carry** - Figure 10-24.

On the command "LET FLY - COLOURS":

- a. While maintaining the grip on the pike, release the Colour with a downward movement of the right hand;
- b. During the march past in quick time, on the command "EYES - RIGHT", the Colour is let fly on the next left foot;
- c. On the command "EYES - FRONT", the Colour is caught.



**Figure 10-24 — Let Fly from the Carry**

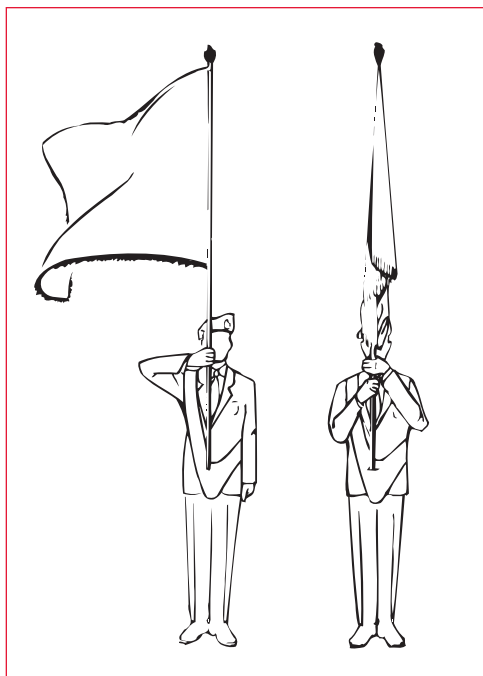
**1051. Catching the Colour From the Let Fly - Figure 10-25.** On the command "CATCH THE - COLOURS":

- a. Grasp the Colour with the left hand and bring it in to the pike;
- b. Simultaneously, grasp the corner of the Colour with the right hand, back of the hand outwards, at the point of the pike where the lowest corner of the Colour reaches;
- c. Cut the left hand to the side to the position of attention and raise the right forearm to the horizontal position.

---

**NOTE: Wind may make Catching the Colour difficult. In such instances, depending on the wind direction, the Colour may be grasped with the right hand after securing the pike in the left hand. Should it not be possible to Catch the Colour it shall be brought to the position of the Order, secured and returned to the Carry.**

---



**Figure 10-25 — Catching the Colour From the Let Fly**

**1052. Dip from the Carry at the Halt** – Figure 10-26. No dipping of colours of any sort shall be practiced by Legion Colour Parties at any function, public or private, with the exception of the Legion Banner at ceremonies for the purpose of Remembrance. At a Remembrance Service, the Legion Banner is dipped slowly, commencing with the first note of *“The Last Post”*. (Also see Section 614.)

To dip (lower) the Legion Banner:

- a. Bring the left hand to a position on the pike above the right hand;
- b. Raise the pike clear of the carrying socket of the sling;
- c. Lower the Legion Banner slowly until the spike of the pike comes to rest on the ground;
- d. The pike is controlled by the upper arm against the body;
- e. Both the elbows are close to the body;
- f. The body is in the position of attention;
- g. The Legion Banner must not touch the ground.



**Figure 10-26 — The Dip**

**1053. Carry From the Dip at the Halt.** The Legion Banner is raised slowly beginning on the first note of "*Rouse*".

To raise the Legion Banner:

- a. Raise the Legion Banner with the right hand, to the perpendicular position of the Carry;
- b. Simultaneously, bring the left hand to the socket of the sling to guide the base of the pike into the socket;
- c. Cut the left hand to the side to the position of attention.

**1054. Draping the Colour** - Figure 10-27. Legion banner is draped on the occasion of a memorial or funeral service. Black crepe mourning ribbon 54 inches (1.35 m) long and six inches (15 cm) wide is tied in a bow below the spike.



**Figure 10-27 — Draping the Colour**

# Remembrance Music

## THE LAST POST



© Jim Paterson

[www.mfiles.co.uk](http://www.mfiles.co.uk)





## ROUSE





March  
♩ = 112

# Unity

Written by Ed Barlow

## Official March of the Royal Canadian Legion

Copied by Miles Jackson  
[www.ma-me-o.com](http://www.ma-me-o.com)

*Dedicated to the memory of Lt. Col. John McCrae*

Piano

Musical notation for measures 1-4. Treble clef, key signature of two flats (Bb, Eb), 2/4 time signature. Chords: Bb, Bb/D, F, F/A, Bb. Dynamics: *ff*. Accents (>) are present over the eighth notes in measures 1, 2, and 3.

Musical notation for measures 5-8. Treble clef, key signature of two flats. Chords: Gm, Gm/Bb, F, F7/A, Bb, F. Dynamics: *mf*.

Musical notation for measures 9-12. Treble clef, key signature of two flats. Chords: Bb, Bb/D, Bb, F. Dynamics: *mf*, *p*. Measure 9 is marked with a box containing the number 9.

Musical notation for measures 13-16. Treble clef, key signature of two flats. Chords: F/A, F7, F7/A, Bb, Gm, F.

Musical notation for measures 17-20. Treble clef, key signature of two flats. Chords: Bb, Bb/D, Bb, F, F7, F/D, F/A, G. Measure 17 is marked with a box containing the number 17.

© 1992 - Royal Canadian Legion



# UNITY (cont'd)

Unity P. 2

Measures 1-4. Treble clef, key signature of two flats. Chords: C/E, C7, F, F7, F, F7/A. Dynamics: *f*.

25

Measures 5-8. Treble clef, key signature of two flats. Chords: B<sup>b</sup>, G<sup>7</sup>, C, F<sup>7</sup>, B<sup>b</sup>.

Measures 9-12. Treble clef, key signature of two flats. Chords: B<sup>b</sup>, E<sup>b</sup>, F, F/A.

33

Measures 13-16. Treble clef, key signature of two flats. Chords: F/C, F/A, B<sup>b</sup>.

Measures 17-20. Treble clef, key signature of two flats. Chords: F/C, C, G<sup>7</sup>/E, F, F/C. Dynamics: *ff*.



# UNITY (cont'd)

Unity P. 3

41

Musical notation for measures 41-44. The key signature has two flats (Bb and Eb). The music is in 4/4 time. Measure 41: Treble clef has a whole note chord Bb. Bass clef has a whole note G. Measure 42: Treble clef has a whole note chord Bb/D. Bass clef has a whole note G. Measure 43: Treble clef has a whole note chord Bb. Bass clef has a whole note G. Measure 44: Treble clef has a whole note chord F7. Bass clef has a whole note G.

Musical notation for measures 45-48. Measure 45: Treble clef has a whole note chord F. Bass clef has a whole note G. Measure 46: Treble clef has a whole note chord F/C. Bass clef has a whole note G. Measure 47: Treble clef has a whole note chord F. Bass clef has a whole note G. Measure 48: Treble clef has a whole note chord Bb. Bass clef has a whole note G.

49

Musical notation for measures 49-52. Measure 49: Treble clef has a whole note chord Bb. Bass clef has a whole note G. Measure 50: Treble clef has a whole note chord Eb. Bass clef has a whole note G. Measure 51: Treble clef has a whole note chord C. Bass clef has a whole note G. Measure 52: Treble clef has a whole note chord G. Bass clef has a whole note G.

Musical notation for measures 53-56. Measure 53: Treble clef has a whole note chord Bb/F. Bass clef has a whole note G. Measure 54: Treble clef has a whole note chord G7. Bass clef has a whole note G. Measure 55: Treble clef has a whole note chord Cm. Bass clef has a whole note G. Measure 56: Treble clef has a whole note chord F7. Bass clef has a whole note G.

57

Musical notation for measures 57-60. Measure 57: Treble clef has a whole note chord Eb. Bass clef has a whole note G. Measure 58: Treble clef has a whole note chord C/E. Bass clef has a whole note G. Measure 59: Treble clef has a whole note chord C/G. Bass clef has a whole note G. Measure 60: Treble clef has a whole note chord Fm. Bass clef has a whole note G.

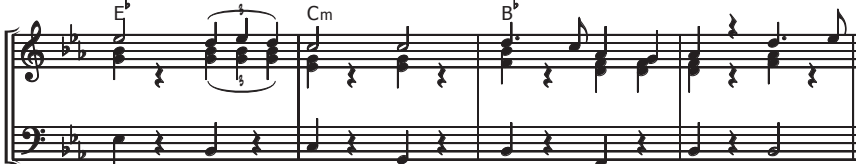
# UNITY (cont'd)

Unity P. 4

Trio: 



65 66 67 68



69 70 71 72

69



73 74 75 76



77 78 79 80

77



81 82 83 84



# UNITY (cont'd)

Unity P. 5

Chords: E<sup>b</sup>, B<sup>b7</sup>, A<sup>b</sup>, C<sup>7</sup>, F<sup>m</sup>, B<sup>b</sup> ⊕

84

Chords: E<sup>b</sup>, F<sup>b</sup>, B<sup>b</sup>, E<sup>b</sup>, E<sup>b</sup>/G, E<sup>b</sup>

Chords: A<sup>b</sup>, B<sup>b</sup>, E<sup>b</sup>, E<sup>b</sup>

Bridge

Chord: C<sup>m</sup>

Chords: B<sup>b</sup>, D.S. al Coda, B<sup>b7</sup>



# UNITY (cont'd)

Unity P. 6

The musical score is presented in two systems, each with a treble and bass staff. The key signature is two flats (B-flat and E-flat), and the time signature is common time (C). The first system begins with a common time signature symbol (C with a vertical line through it). The first staff of the first system contains a melodic line with notes G4, A4, B4, and C5, with rests in between. The second staff contains a bass line with notes G2, F2, E2, and D2. Chord symbols are placed above the first staff: A<sup>b</sup>, F/C, F/A, E<sup>b</sup>, E<sup>b</sup>/B<sup>b</sup>, and E<sup>b</sup>/G. The second system continues the melodic line with notes D5, C5, B4, and A4. The bass line continues with notes G2, F2, E2, and D2. Chord symbols for the second system are A<sup>b</sup>, B<sup>b</sup>, B<sup>b</sup>/F, and E<sup>b</sup>. The piece concludes with a double bar line and the word "Fine" written above the final measure.



## **ROYAL ANTHEM**

God save our gracious King  
Long live our noble King,  
God save The King:  
Send him victorious,  
Happy and glorious,  
Long to reign over us:  
God save The King.

## **HYMNE ROYAL**

Que Dieu protège notre gracieux Roi,  
Longue vie à notre noble Roi,  
Que Dieu protège le Roi!  
Rends-le victorieux,  
Heureux et glorieux;  
Que soit long son règne sur nous,  
Que Dieu protège le Roi!



# LEGION MEDALS AND PRECEDENCE



The above photograph displays a representative set of Legion medals that have been court mounted.

The medals are worn on the wearer's right side of the blazer. The precedence of the medals (shown above) from right to left when viewed from the front is as follows:

- a. The Meritorious Service Medal (MSM) with Palm Leaf;
- b. A Past Provincial Officer's medal with a Vice-President's Bar;
- c. A District Past Officer's medal with a District Bar;
- d. A Zone Past Officer's medal with a Zone Bar;
- e. A Branch Past President's medal;
- f. A Branch Past Officer's medal with a 1st Vice-President's Bar; and
- g. An Anniversary Medal, in this case the 90th Anniversary Medal.

THE MATERIAL PROVIDED IN THIS PUBLICATION IS THE SOLE PROPERTY OF THE ROYAL CANADIAN LEGION AND SHALL NOT BE REPRODUCED IN ANY FORM WITHOUT THE EXPRESSED WRITTEN PERMISSION OF DOMINION COMMAND, THE ROYAL CANADIAN LEGION. THIS MANUAL AMPLIFIES LEGION POLICY AND IS PRODUCED UNDER THE AUTHORITY OF THE DOMINION EXECUTIVE COUNCIL AS PER ARTICLE 408 OF THE GENERAL BY-LAWS.



**Dominion Command**

86 Aird Place, Ottawa, ON  
Canada K2L 0A1

**legion.ca**

